

ORIGIN[®]

Graphing & Analysis

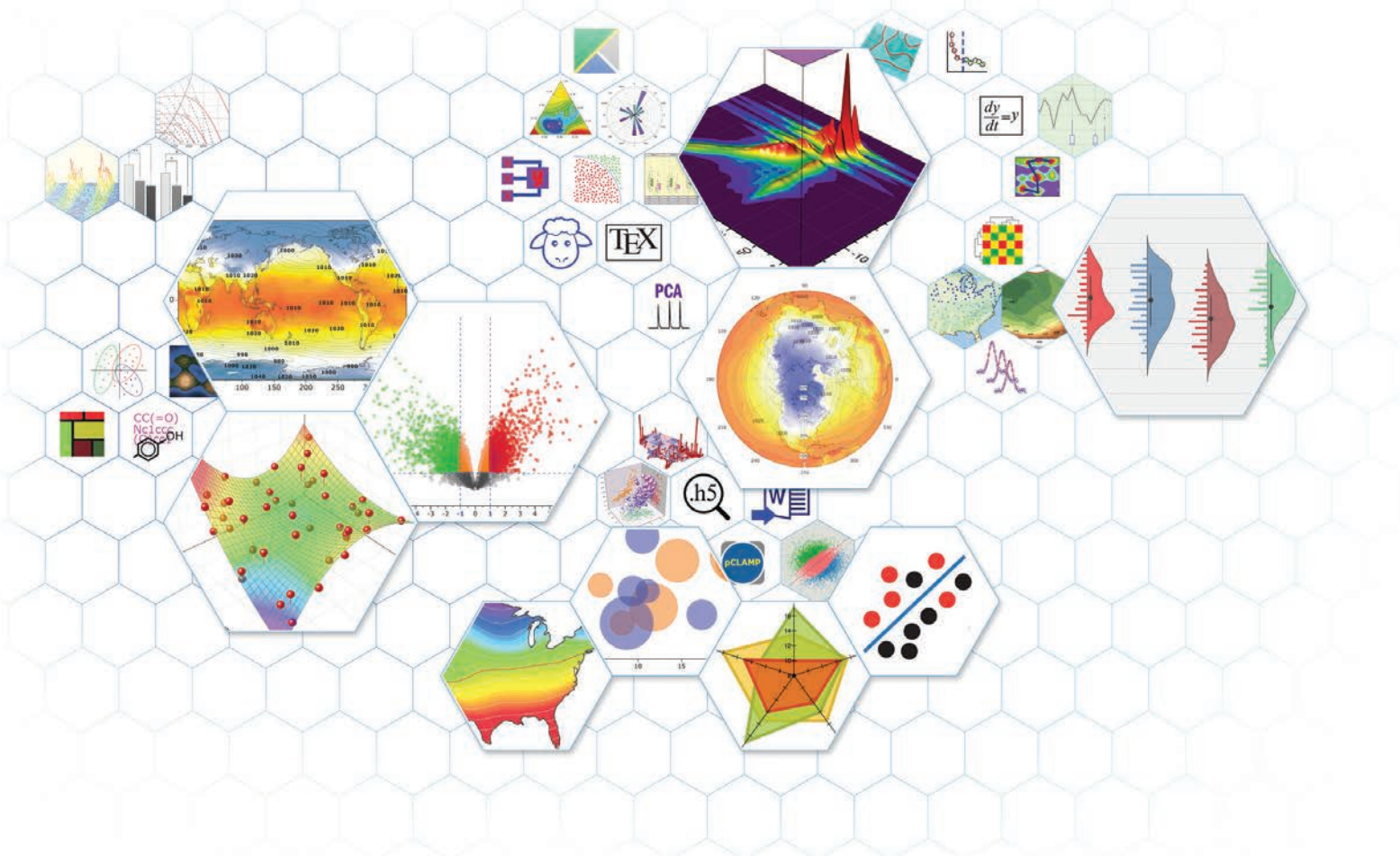

Introduction to Origin and OriginPro	2	Handling Repetitive Tasks	28-31
2D Graphing	4-11	Custom Reports	32
3D Graphing	12	Publishing	33
Database Access	14	Working with Excel [®] , MATLAB [®] Connectivity	34
Data Processing	16	LabVIEW [™] Connectivity	35
Gadgets	18	Programming	36-39
Apps in Origin	19	User Case Studies	40
Curve Fitting	20	Comparison of Origin and OriginPro	42
Peak Analysis	22	Licensing	44
Signal Processing	24	Product Support	46
Statistics	26	About OriginLab	47

25+ years serving the scientific and engineering community.

ORIGIN[®] From Data to Results

Origin is a user-friendly and easy-to-learn software application that provides powerful data analysis and publication-quality graphing capabilities tailored to the needs of scientists and engineers.

OriginPro offers all of the features of Origin plus extended analysis tools for Peak Fitting, Surface Fitting, Statistics, Signal Processing, and Image Handling.

Origin allows you to customize operations such as importing, graphing and analysis, all from the GUI. Origin also automatically updates all graphs, analysis results and reports when data or parameters change. This allows for batch analysis of multiple files or datasets without the need for programming.

Import, Query, Connect

Import data from ASCII, CSV, Excel[®] or Third-Party data files. Query database, or send data and commands to Origin from client applications such as LabVIEW[™], MATLAB[®], or Excel.

File Import ASCII, CSV, Excel, Third Party File Formats

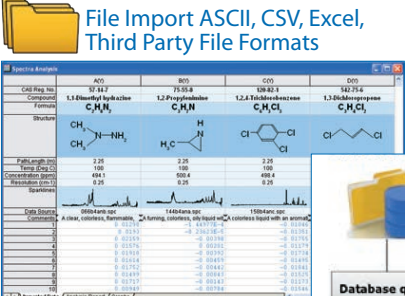

Multisheet Workbook with Metadata Label rows and Sparklines

Database Access



Database query

- Query setup
- Query Builder
- SQL Editor

LabVIEW[™] Sub VIs

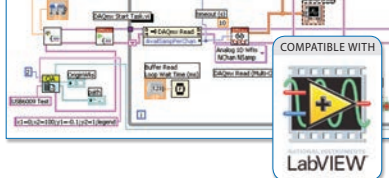

MATLAB[®] Console

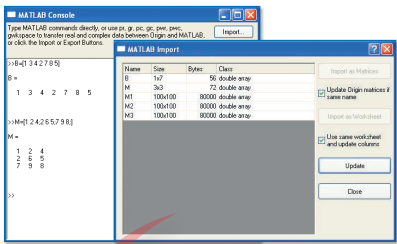

MATLAB Import

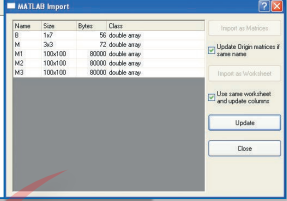

Graph, Explore

Create and customize publication quality graphs with ease. Save customizations as a template or Theme for repeat use. Explore data graphically including easy zoom and scroll within layers.

The Data Info tool lets you explore data from your graph, including display of related information from other columns

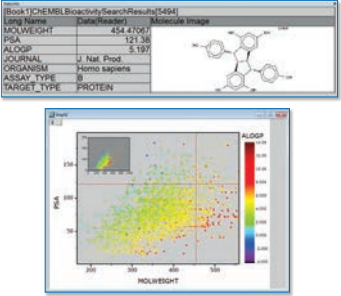

Explore data graphically including easy zoom and scroll

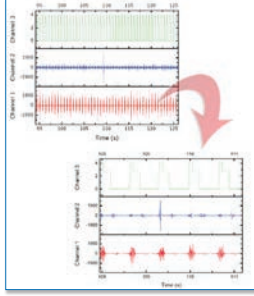

Create publication-quality 2D and 3D graphs using built-in or custom templates

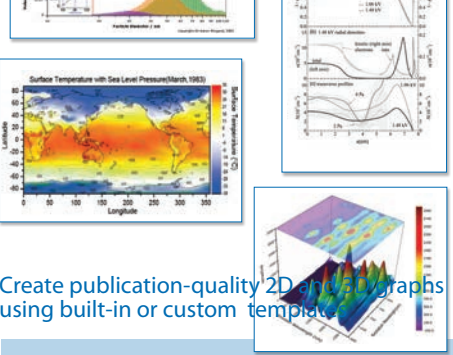

"Yet again Origin and OriginPro upholds its foremost status as the best purposeful and all-embracing data analysis and graphing software on the market. Although other software packages exist, few are as straightforward to use, flexible, and high-quality when it comes to performing challenging data analysis or creating publication superior graphs."

Keith J. Stevenson, Professor of Chemistry, The University of Texas at Austin

Publish, Present, Report

Create publication-quality reports inside Origin, or embed graphs in Word® and PowerPoint®.

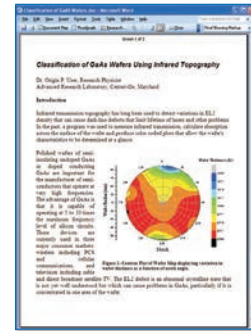
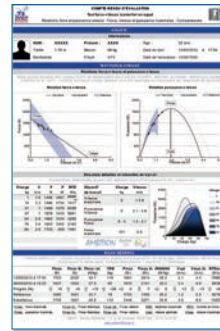

Custom Report Sheets created by combining graphs and analysis results

Copy and OLE-paste graphs in Word

Recalculate analysis results, and update graphs and reports by simply importing new data.

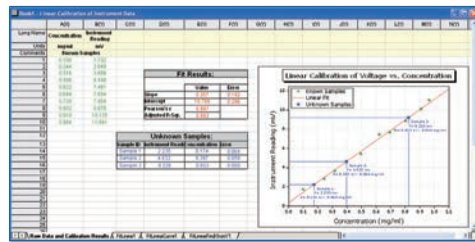

Analysis Template™ combining data, results, and floating graph

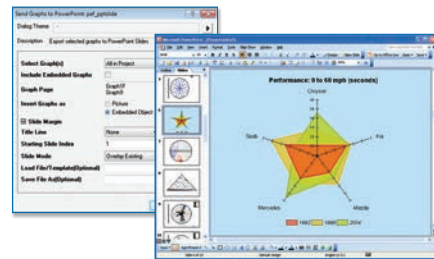

Send graphs to PowerPoint or view as slide show within Origin

Reduce, Summarize, Analyze

Reduce, summarize, and analyze data. Use Gadgets to graphically analyze data within a region of interest.

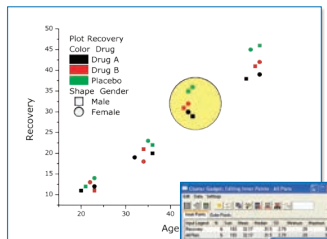

Use Gadgets for interactive analysis on data in graphs

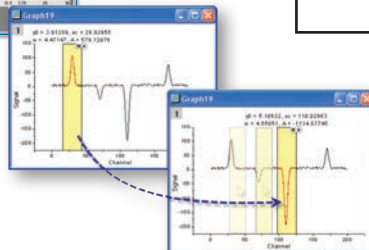

Origin provides advanced data analysis tools such as the Nonlinear Curve Fitter

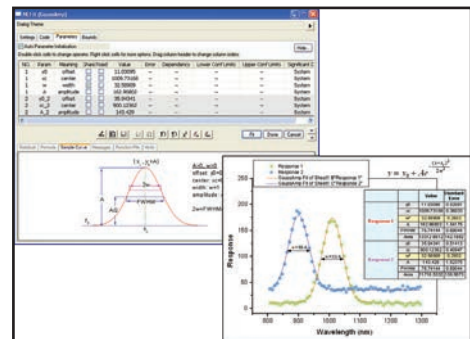

2D Graphing

Origin provides many 2D graph templates including line, symbol, column, bar, pie, stock, statistical, contour and area. Specialized plot types include ternary, polar, vector, windrose, and waterfall.

Origin graphs can contain multiple XY axis pairs (layers) that can be arranged arbitrarily, including support for linking axes across layers. Multiple X and/or Y axes with offsets are supported. All graph elements can be easily and extensively customized, including color transparency and gradients.

Graph customization can be saved to a template or as a theme for repeated use.

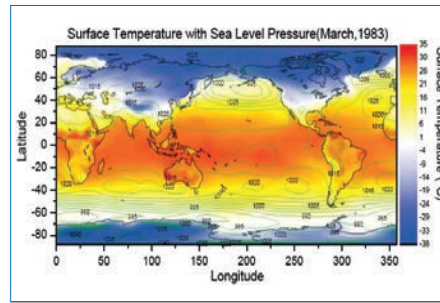

Overlay of Two Contour Plots

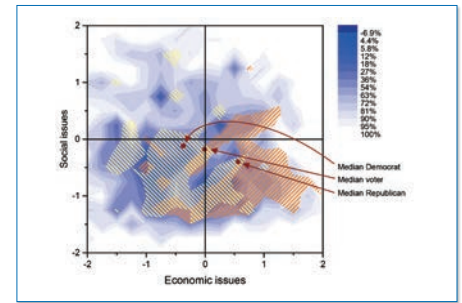

Pattern Fill Contour with Annotations

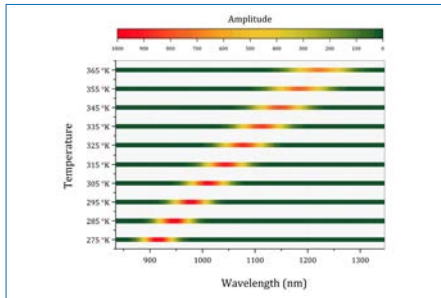

Flattened Waterfall

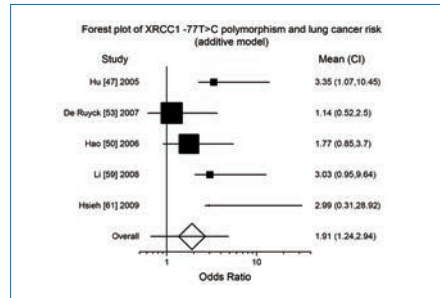

Forest Plot

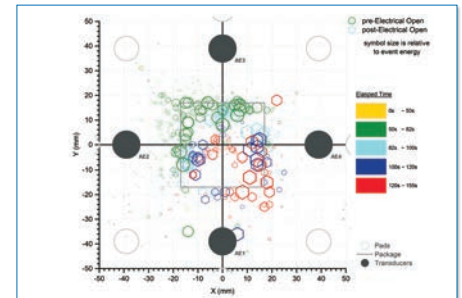

Scatter Plot with Color and Size Mapping

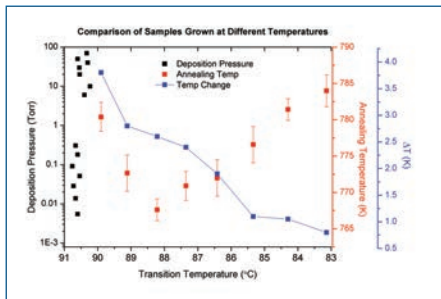

Overlapping Layers with Linked X Axis

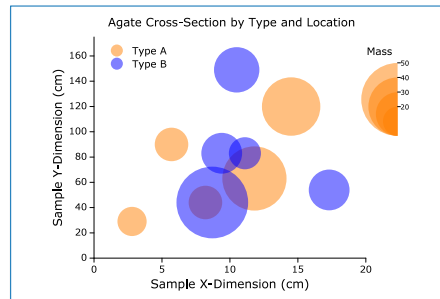

Bubble Plot with Indexed Colors

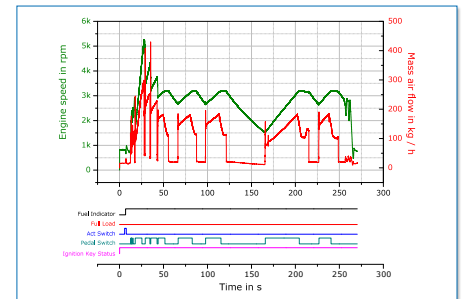

Bitspur Plot

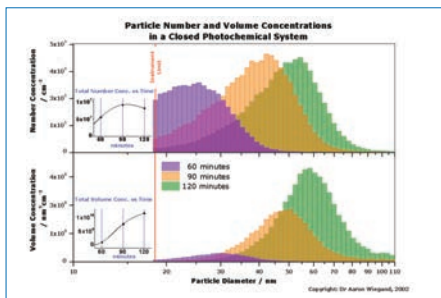
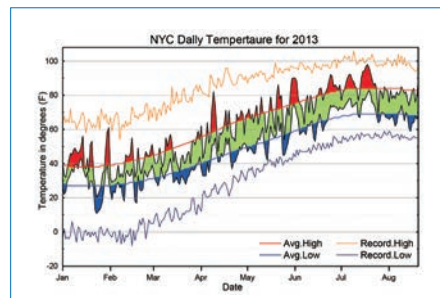
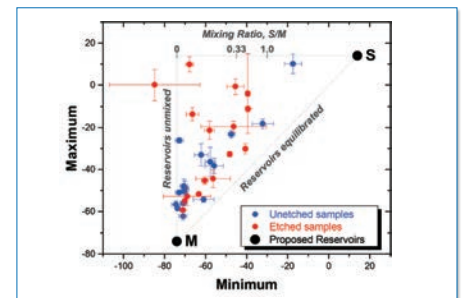

Chart with Inset Layers and Transparency



Line Plot with Above/Below Fill Color



Scatter with X and Y Error

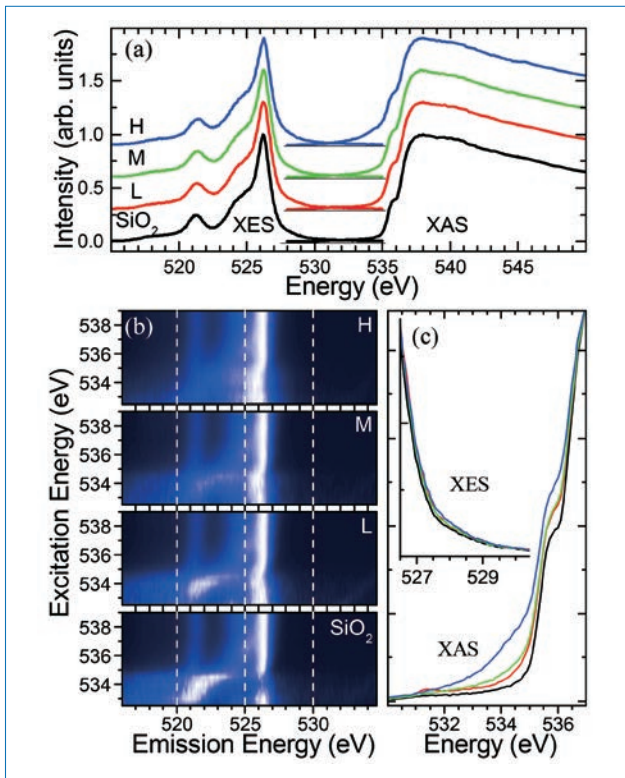

Arbitrary Arrangement of Graph Layers

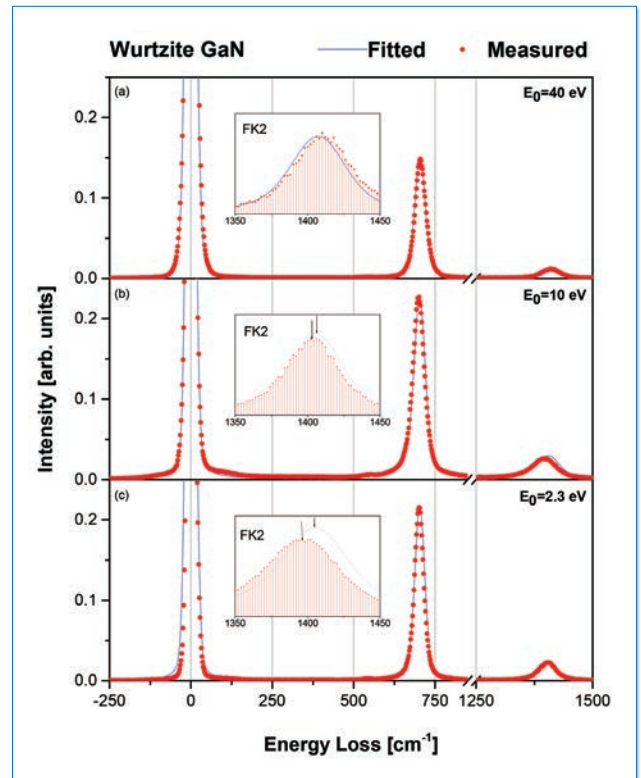

Stacked Layers with Linked X Axis

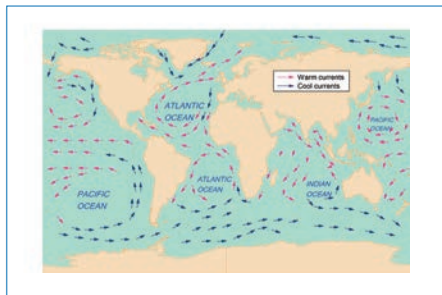

Fill Area with Vector Overlay

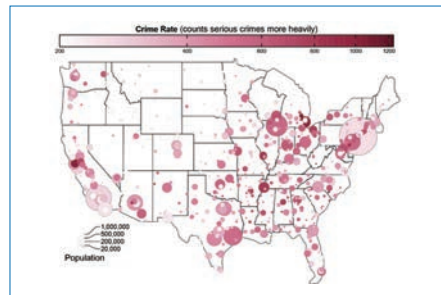

Bubble Plot on Map

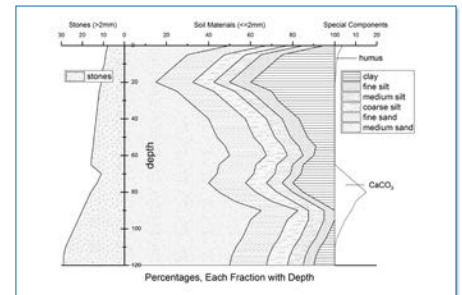

Stacked Area Plot with Geo Patterns

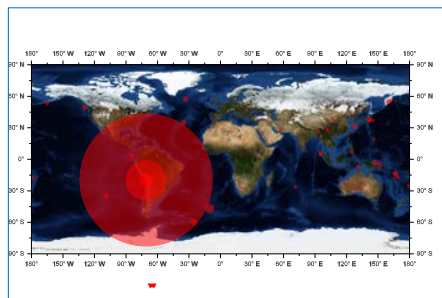

Bubble Plot on Map

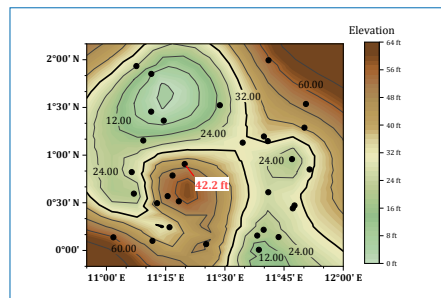

DMS Formatting of Labels

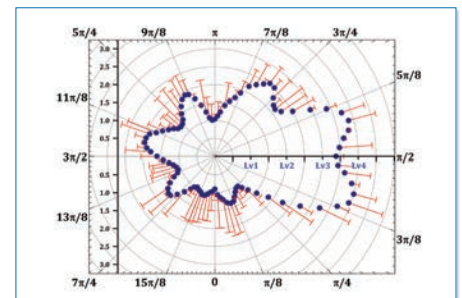

Polar Plot with Cropped Axis

2D Graphing (continued...)

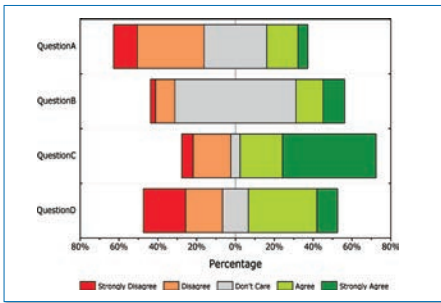

Likert Scale

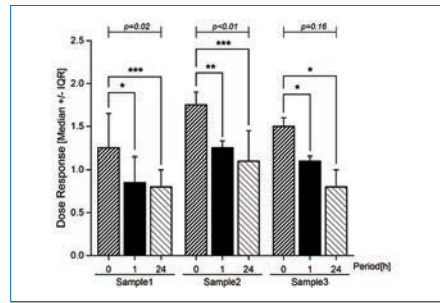

Grouped Column Plot with Asterisk and Bracket

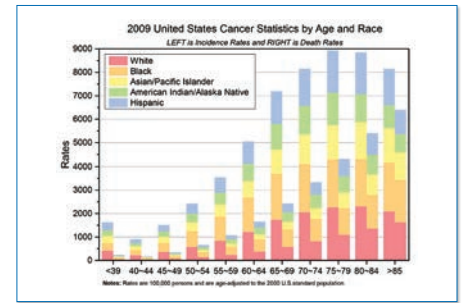

Grouped Stacked Column

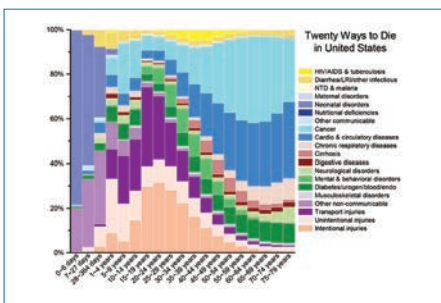

100% Stacked Column

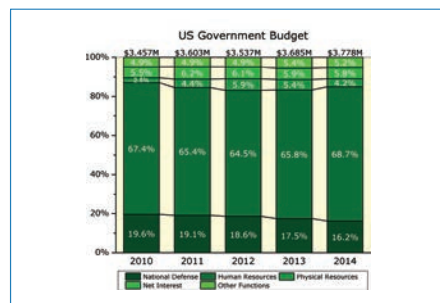

100% Stacked Column Plot with Line Connect

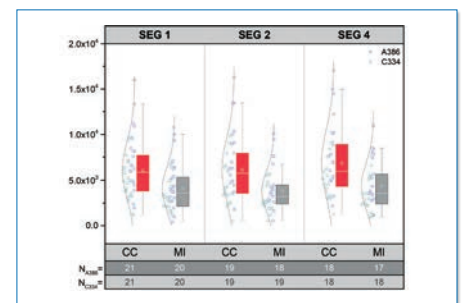

Grouped Box Chart with Color-Indexed Data Points

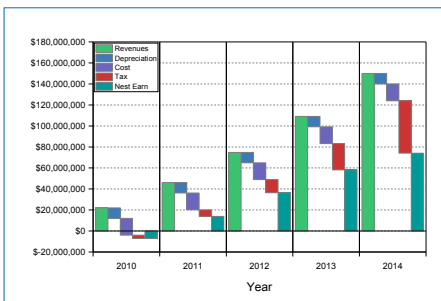

Bridge Chart with Multiple Panels

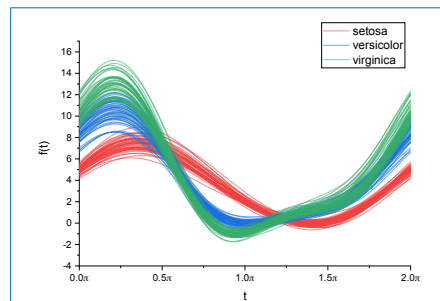

Andrews Plot

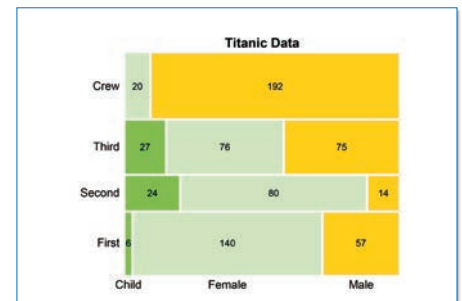

Mosaic Plot

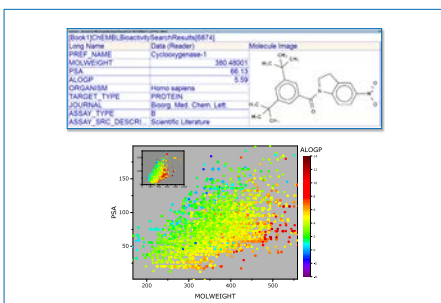

Scatter Plot and Data Info Dialog

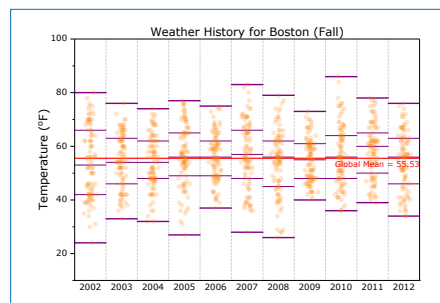

Column Scatter with Reference Lines

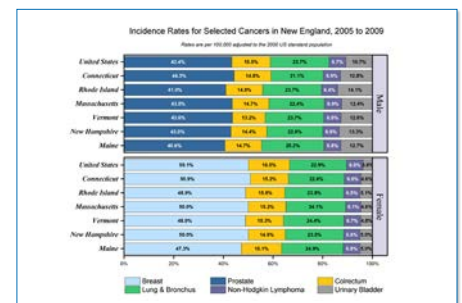

100% Stacked Bar with Grouping

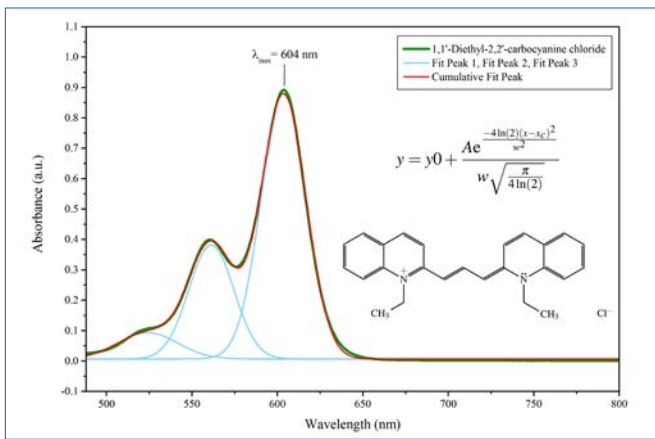

Annotation with Equation and Molecular Image

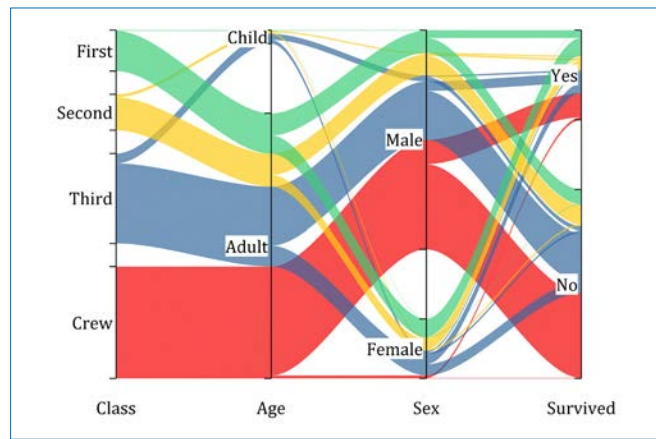

Parallel Plot

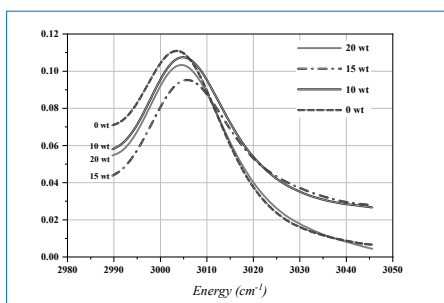

Black & White Line Plot

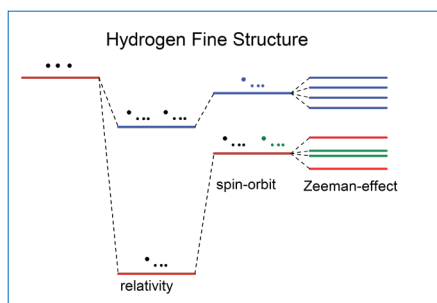

Energy Diagram

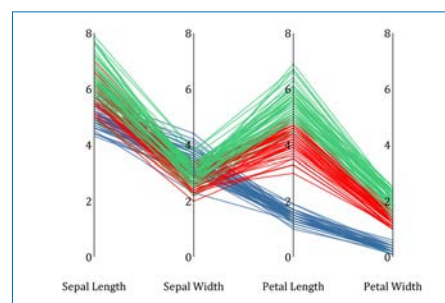

Parallel Plot with Common Axis Range

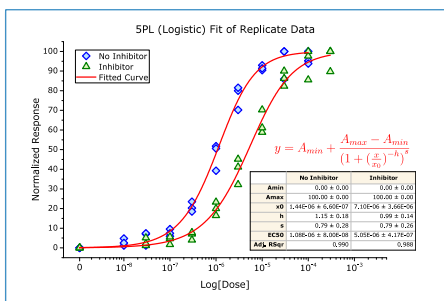

Dose Response Analysis

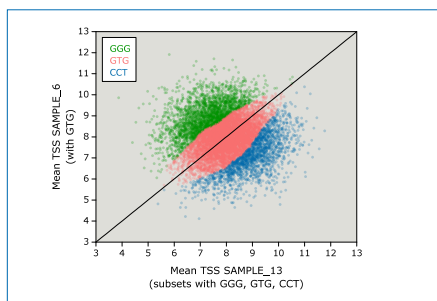

Scatter with Color Indexing

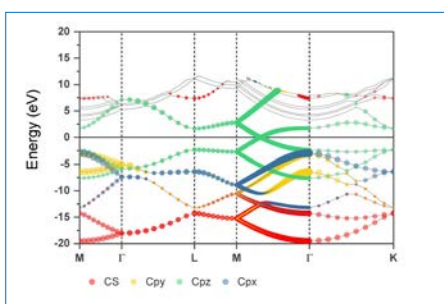

Band Structure Diagram

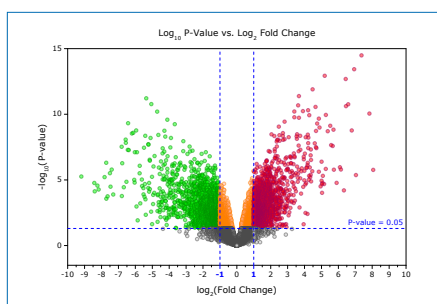

Volcano Plot

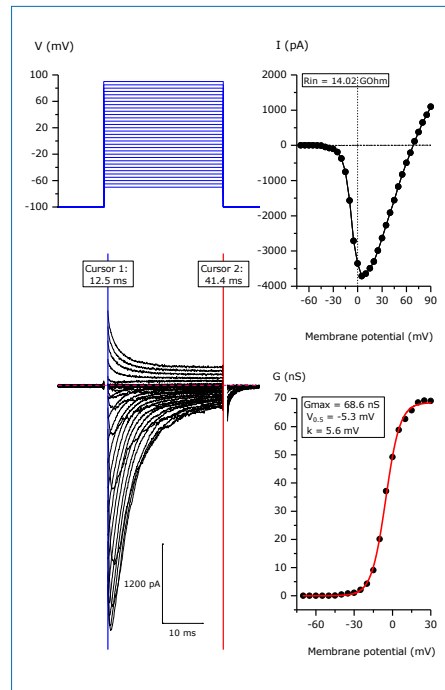

Multipanel Plot of pCLAMP Data

2D Graphing (continued...)

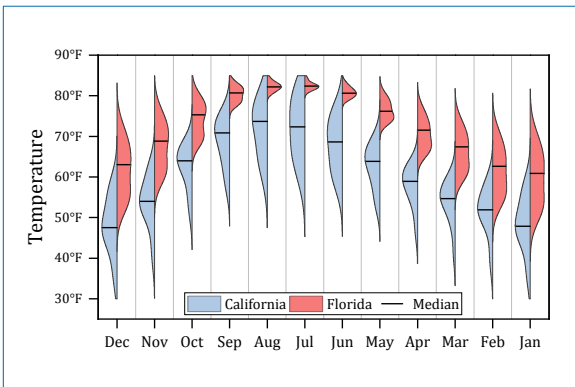

Split Violin

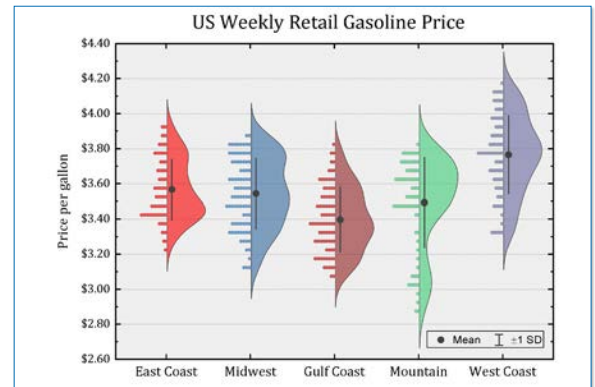

Half Violin with Data

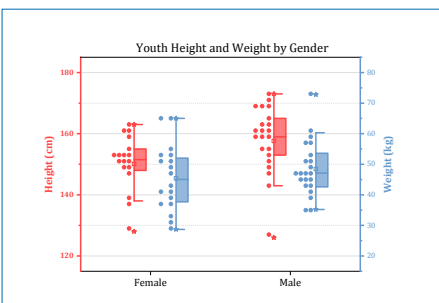

Double-Y Half Box

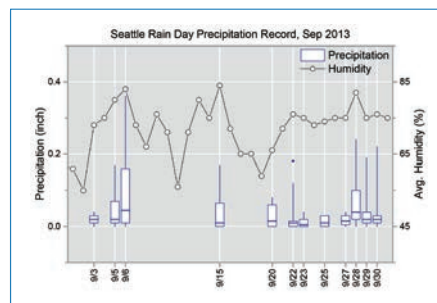

Box Chart with Variable Position

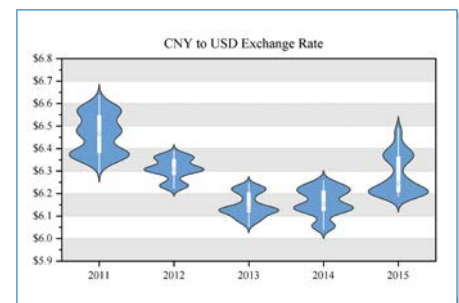

Violin with Box

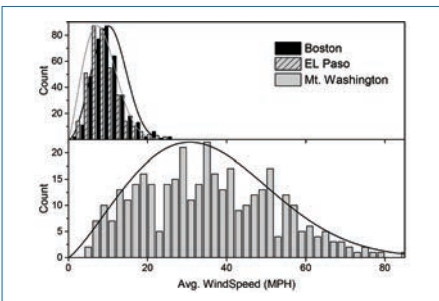

Stacked Histogram with Weibull Curve Overlay

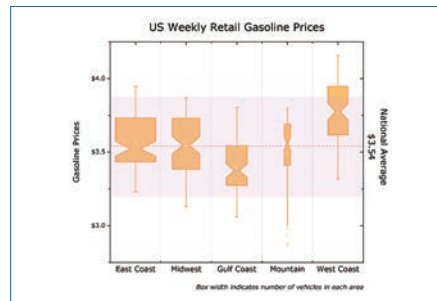

Box Chart with Variable Width

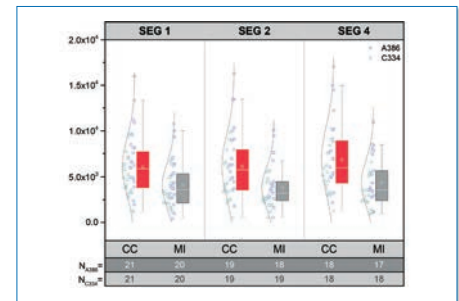

Grouped Box Chart with Color-Indexed Data Points

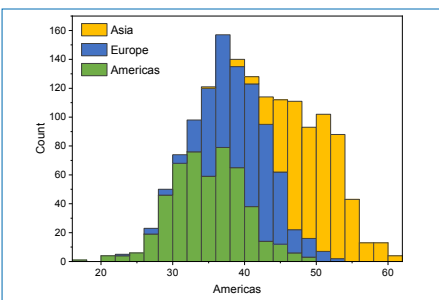

Stacked Histogram

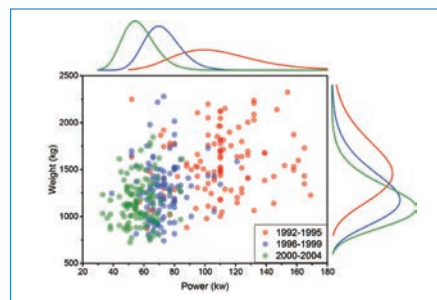

Marginal Distribution Curve Plot

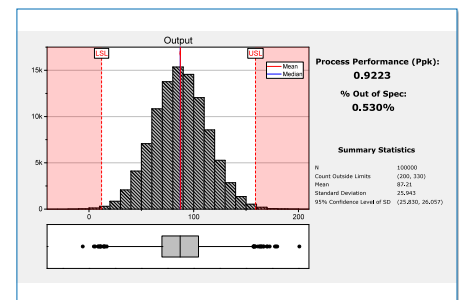

Monte Carlo Simulation

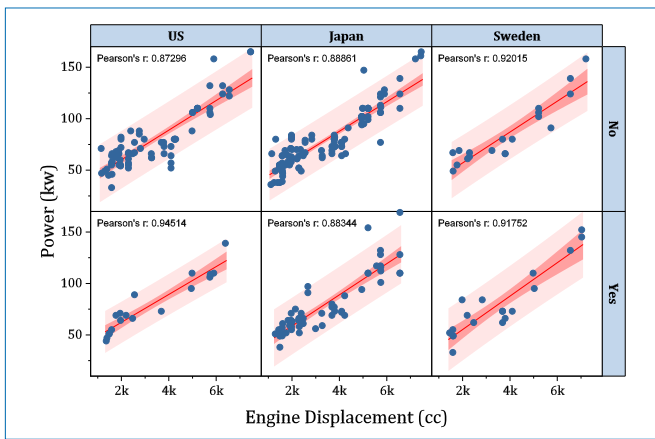

Trellis Plot with Linear Fit

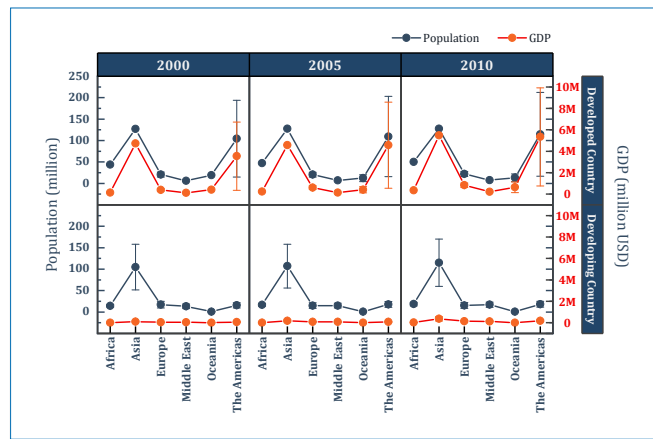

Double-Y Trellis Plot

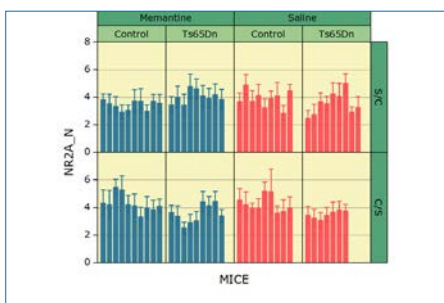

Trellis Plot

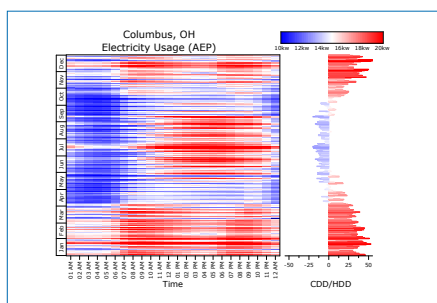

Heat Map

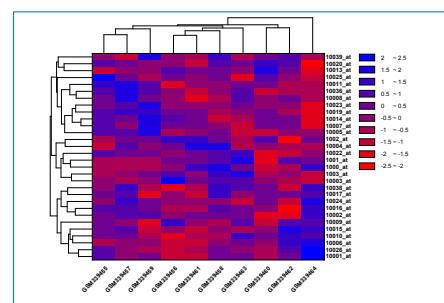

Heat Map with Dendrogram

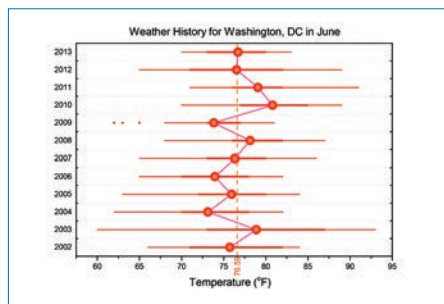

Horizontal Box Chart with Means Connected

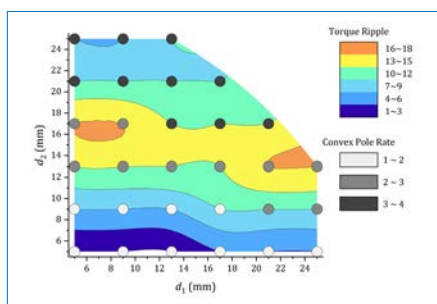

Contour with Categorical Data

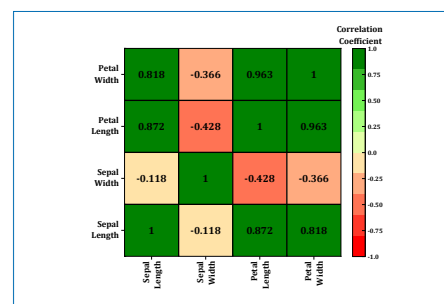

Heatmap with Labels

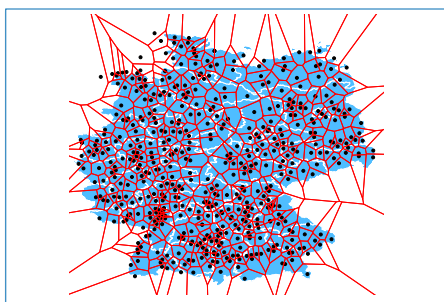

Voronoi Diagram

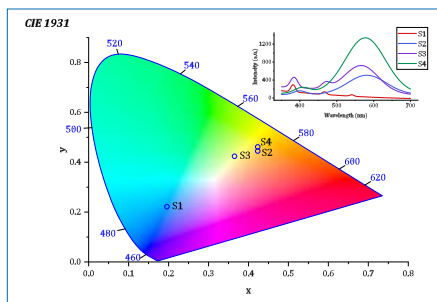

Chromaticity Diagram

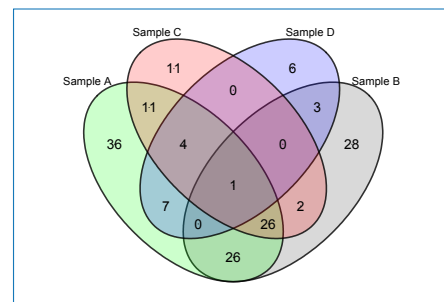

Venn Diagram

2D Graphing (continued...)

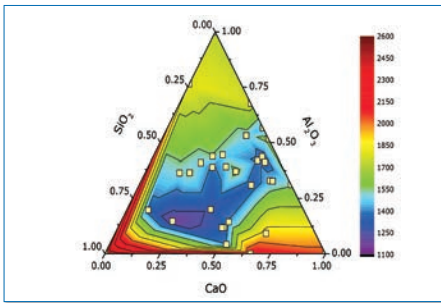

Ternary Contour

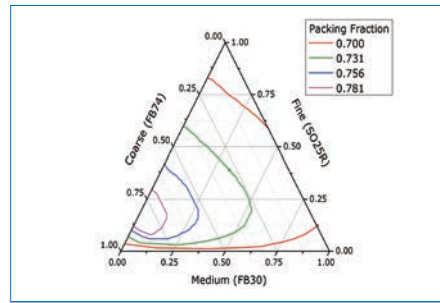

Ternary Plot

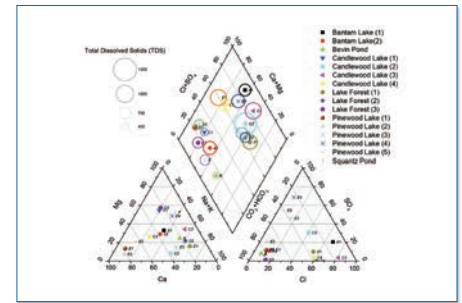

Piper Diagram

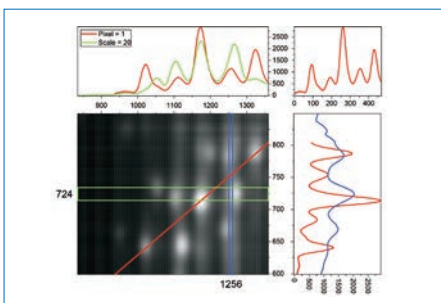
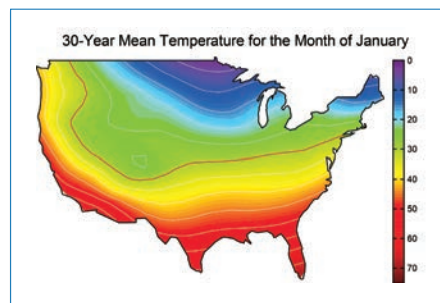
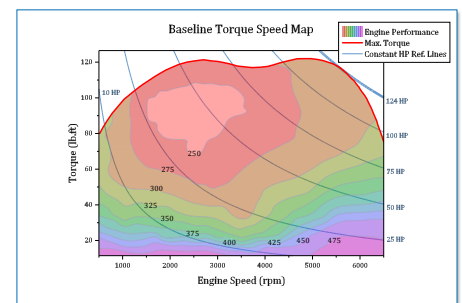

Image Profile



Contour Plot with Custom Boundary



Contour with Reference Lines

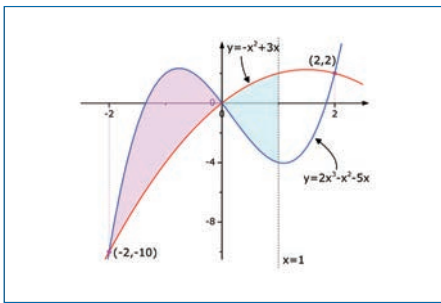

Function Plot with Fill Area

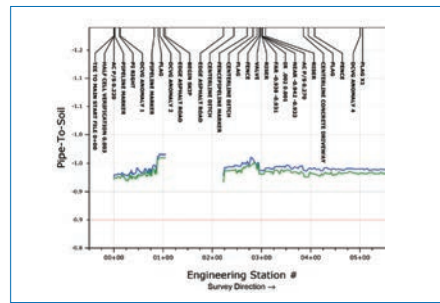

Smart Labeling with Leader Lines

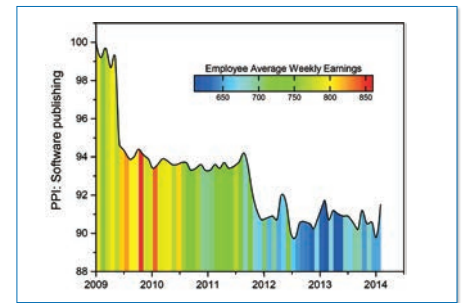

Fill Area Color Mapped to Another Dataset



Grouped Line Plot with Log Scale

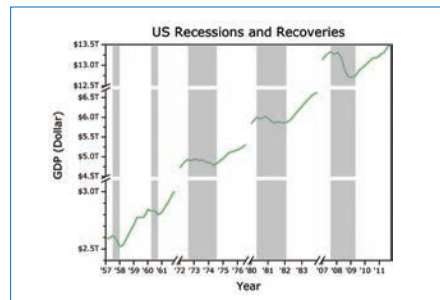

Multiple Axis Breaks and Reference Lines

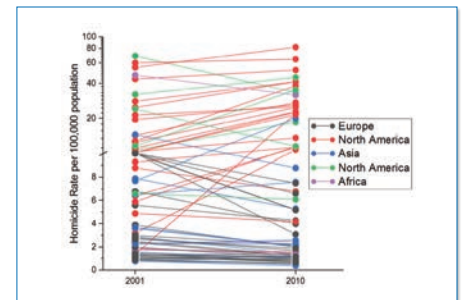

Two-point Segment with Custom Legend

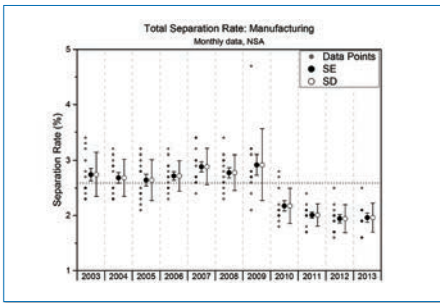

Scatter with Offset

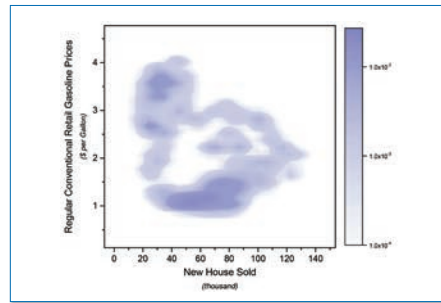

2D Kernel Density Plot

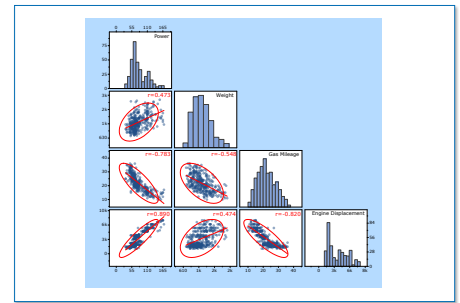

Scatter Matrix with Histograms

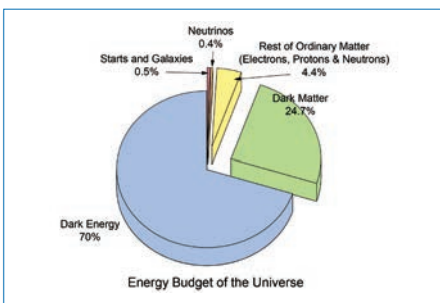

3D Pie Chart

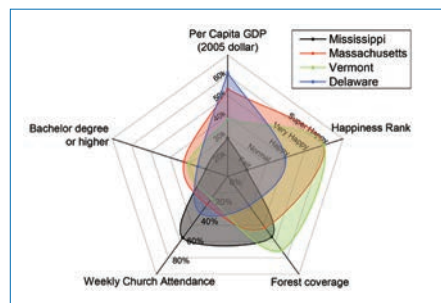

Radar Chart

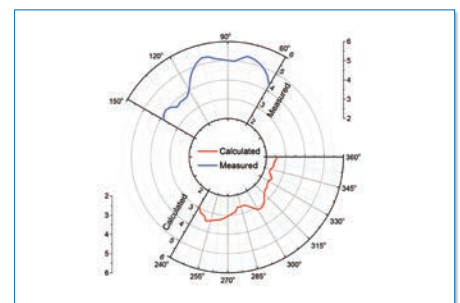

Multi-Layer Polar Plot

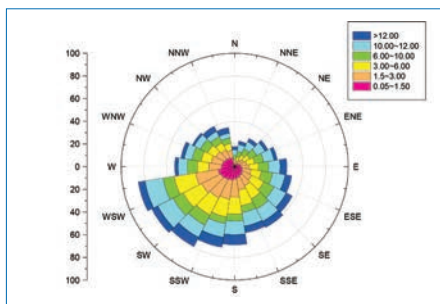

Windrose Plot

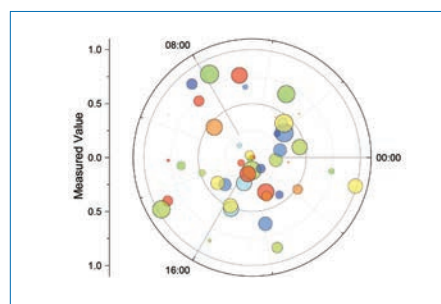

Polar Scatter

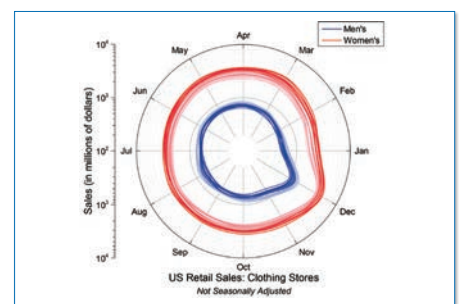

Polar Line Plot with Colormap

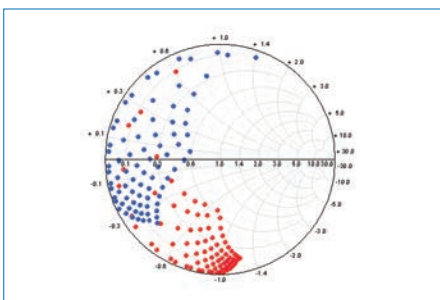

Smith Chart

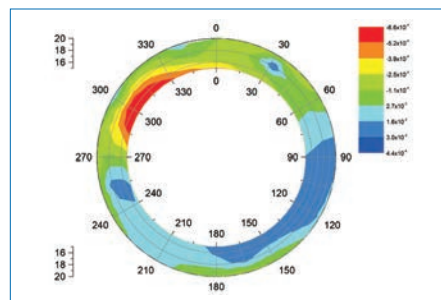

Donut Contour

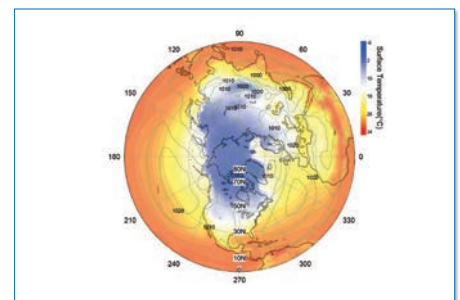

Polar Contour

3D Graphing

Origin provides high-performance 3D graphs and parametric function plots, created using OpenGL. Many built-in templates such as wireframe, colormap surface with contour projection, scatter, bars, ribbons, and walls are provided. Multiple datasets can be plotted in the same layer, with ability to stack and flatten each dataset individually. Error bars are supported for many of the plot types. Changes can be saved as template or theme for repeat use.

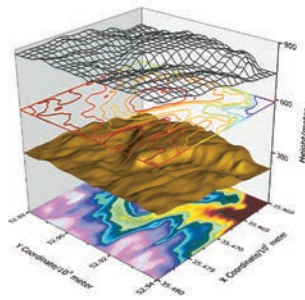

Stacked Plot with Contour, Surface, and Wireframe

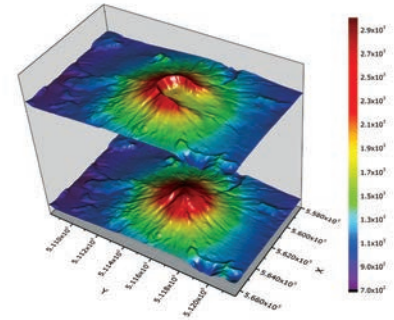

Stacked Surface Plot

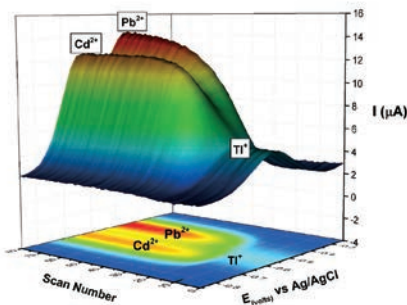

Surface Plot with Contour Projection

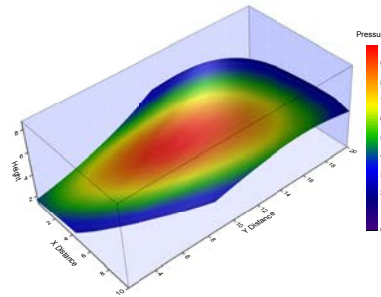

Surface Plot with Colormap from Another Dataset

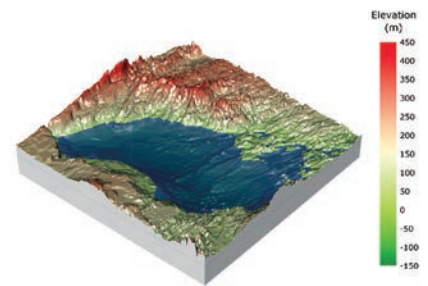

Surface Plot with Constant Plane

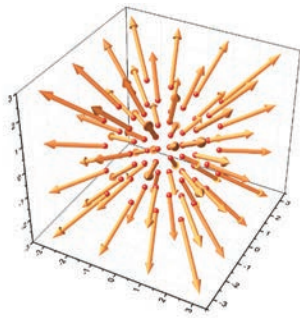

3D Vector Plot

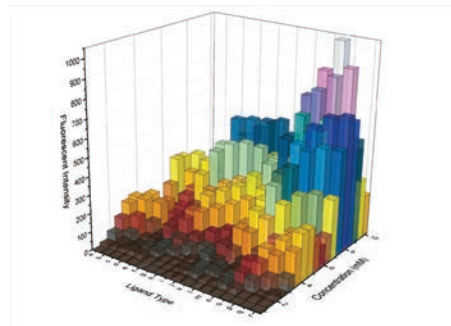

Bar Plot with Transparency

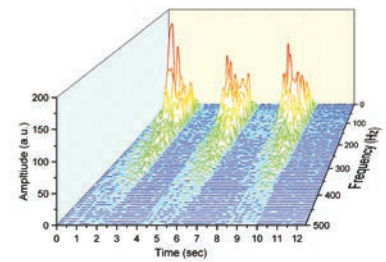

Waterfall with Y-Color Mapping

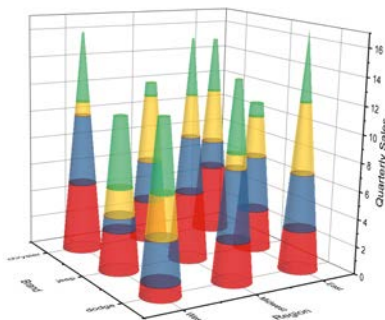

3D Stacked Bars with Transparency

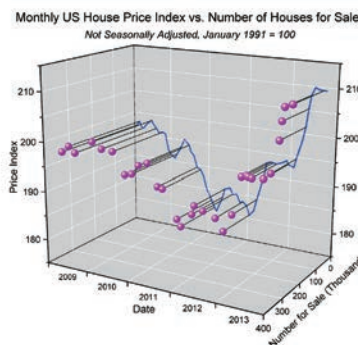

Scatter with Projection and Drop Line

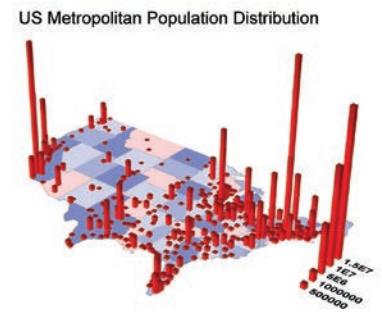

Contour and Bar Plot

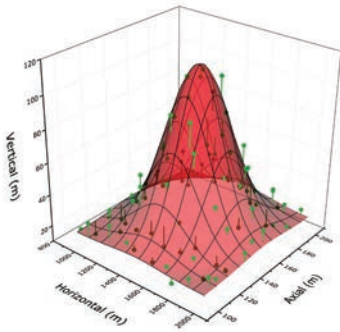

Surface Plot with Scatter and Drop Lines to Surface

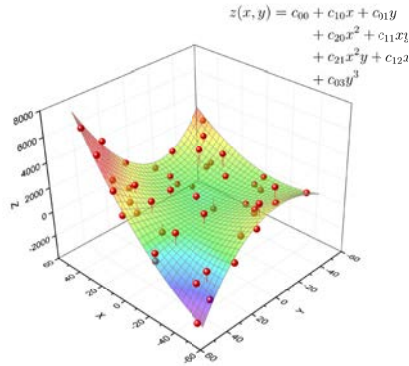

Surface Fit with Polynomial Equation

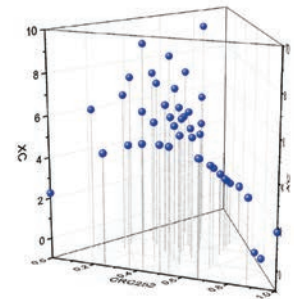

Ternary Scatter with Drop Line

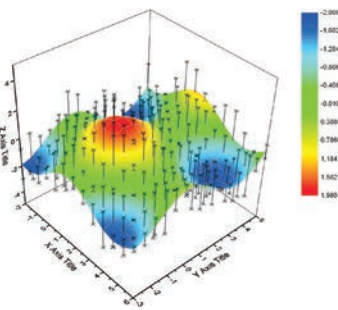

Surface with Error Bars

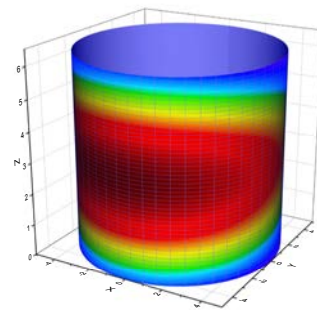

Cylinder with wrapped Contour Plot

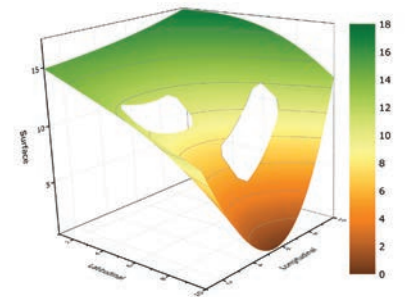

Surface Plot with Missing Values

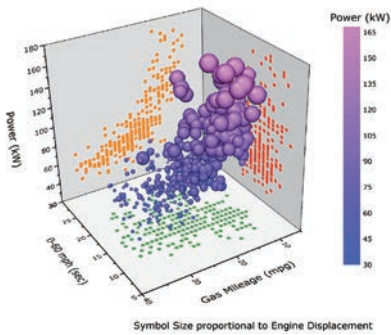

Scatter Plot with Size and Color Mapping

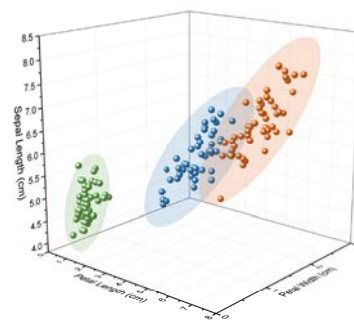

3D Scatter with 95% Confidence Ellipsoids

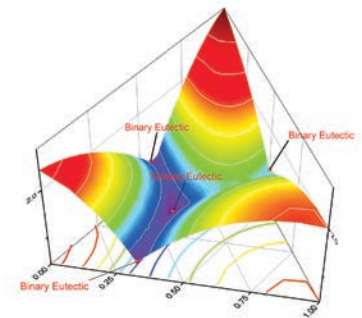

Ternary Surface

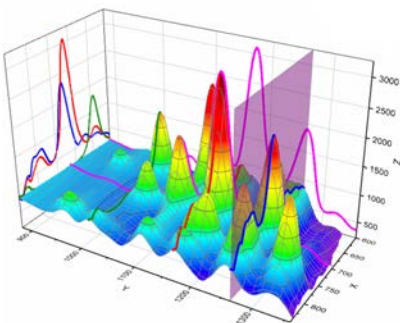

3D Wall Profiles

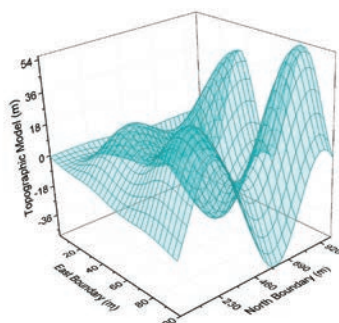

Wireframe Plot

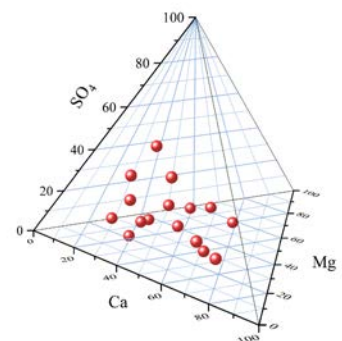

Tetrahedral Plot

Database Access

Origin provides easy-to-use tools for database access. Connection and query information can be saved for future use in the workbook or project, allowing for greater ease and efficiency in working with databases.

Origin supports accessing and importing from many databases including:

- Microsoft Excel
- Microsoft Access
- Microsoft SQL Server®
- Oracle®
- MySQL®

SQL Editor

The SQL Editor tool in Origin is intended for users who prefer to work directly within the SQL environment. Quickly connect to a database by editing the connection string and SQL code in the syntax-highlighted editor. The editor is fully integrated with LabTalk, allowing the use of LabTalk commands and variables in an SQL query.

With the SQL Editor, you can:

- Fine tune how your data is brought into Origin
- Use aliases to make the SQL script more intuitive, easier to read, and faster to create
- Perform left or right joins when inter-joining tables
- Create union sub-queries

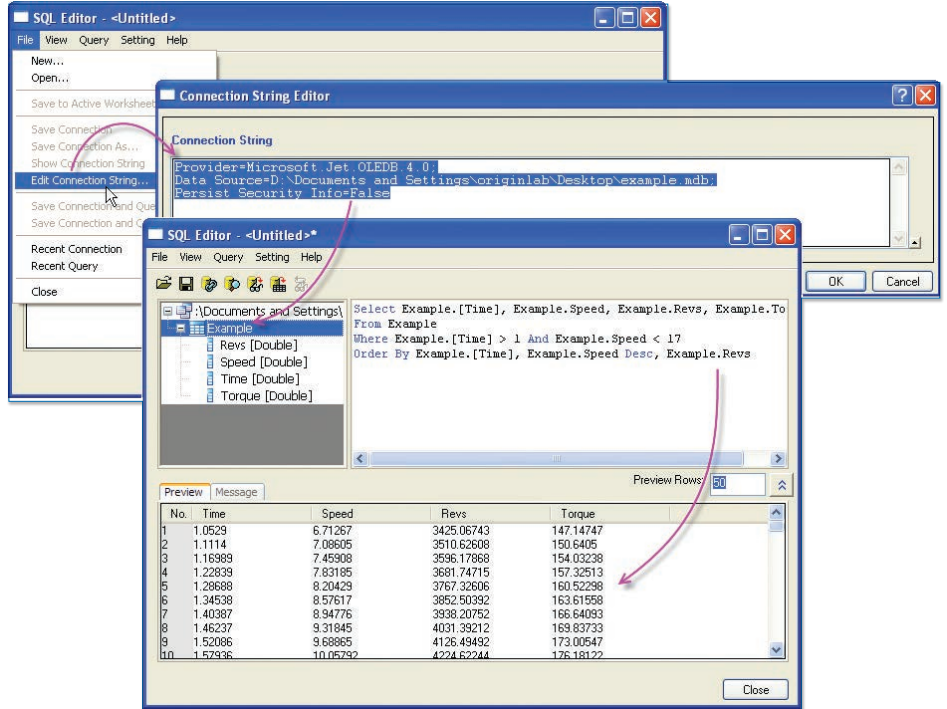

In SQL Editor, enter connection string and preview query results

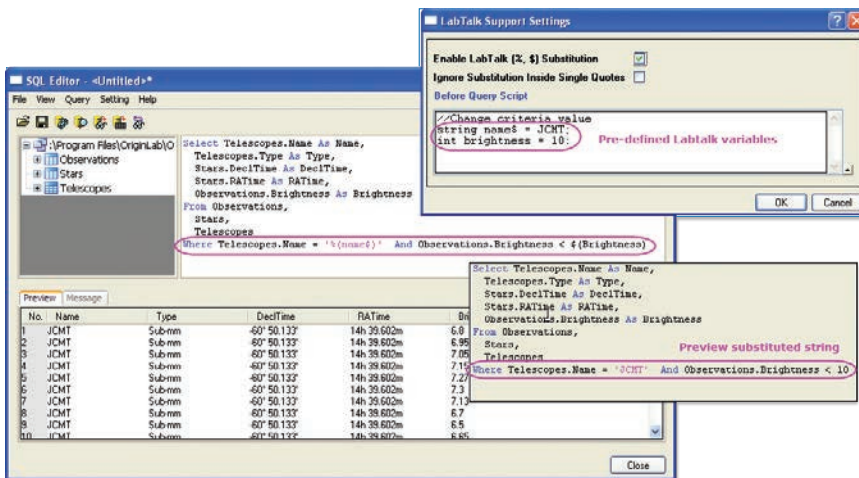

Use LabTalk substitution and pre-defined LabTalk variables in SQL query code

Query Builder

The Query Builder tool in Origin is a graphical interface that allows users to visually construct SQL queries, save named queries, and more.

This tool can detect relationships between tables and automatically create appropriate joins. Use Query Builder to define grouping, sorting, unions, sub-queries, and more, for creating complex SQL queries.

Connection and query information can be saved for future use.

With the Query Builder, you can:

- Manually type SQL code or create graphically
- View query tree and available database objects (tables)
- Drag and drop the desired tables from the object viewer to create your query
- Preview your query results before importing
- Save your named query with the worksheet and it then automatically reflects database change
- Re-run your query at any time to see the most current version of your data
- Copy queries from one worksheet to another
- View your query information in the Workbook Organizer
- Use your saved query as part of an Analysis Template™

Note: This tool is currently available only in the 32-bit version of Origin.

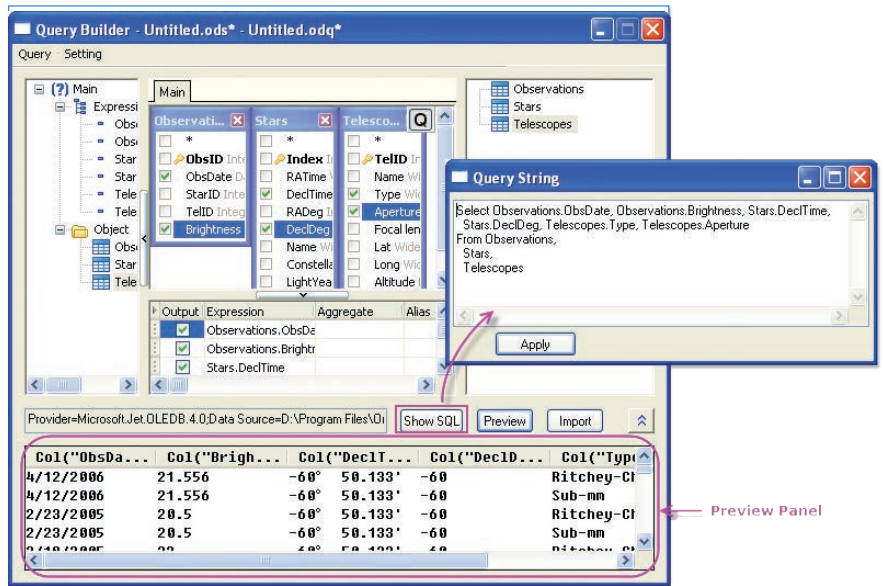

The Query Builder dialog

Post Import Data Processing

As a powerful data analysis and graphing software, Origin provides a wide array of tools to perform post processing of data imported from a database:

- Generate publication-quality 2D or 3D graphs with large datasets, and easily zoom and pan within the graph to visualize your data
- Use data reduction tools such as data filter or pivot table to reduce or summarize large data
- Perform analysis operations on your data such as curve fitting or statistical analysis
- Automatically update graphs and analysis results when you re-import data, or change data or analysis parameters

Database Server

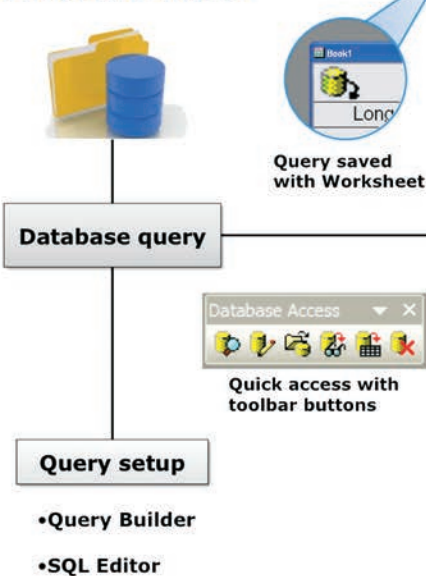

	A(0)	B(0)	C(0)	D(0)	E(0)
Long Name	Units				
Comments					
1	UKJRT	Ritchey-Chretien	-60° 50.133'	14h 39.602m	21.556
2	JCMT	Sub-mm	-60° 50.133'	14h 39.602m	21.556
3	UKJRT	Ritchey-Chretien	-60° 50.133'	14h 39.602m	20.5
4	JCMT	Sub-mm	-60° 50.133'	14h 39.602m	20.5
5	UKJRT	Ritchey-Chretien	-60° 50.133'	14h 39.602m	22
6	JCMT	Sub-mm	-60° 50.133'	14h 39.602m	22
7	UKJRT	Ritchey-Chretien	-60° 50.133'	14h 39.602m	6.8
8	JCMT	Sub-mm	-60° 50.133'	14h 39.602m	6.8
9	UKJRT	Ritchey-Chretien	-60° 50.133'	14h 39.602m	6.95
10	JCMT	Sub-mm	-60° 50.133'	14h 39.602m	6.95
11	UKJRT	Ritchey-Chretien	-60° 50.133'	14h 39.602m	7.05
12	JCMT	Sub-mm	-60° 50.133'	14h 39.602m	7.05
13	UKJRT	Ritchey-Chretien	-60° 50.133'	14h 39.602m	7.15
14	JCMT	Sub-mm	-60° 50.133'	14h 39.602m	7.15
15	UKJRT	Ritchey-Chretien	-60° 50.133'	14h 39.602m	7.27
16	JCMT	Sub-mm	-60° 50.133'	14h 39.602m	7.27
17	UKJRT	Ritchey-Chretien	-60° 50.133'	14h 39.602m	7.3
18	JCMT	Sub-mm	-60° 50.133'	14h 39.602m	7.3
19	UKJRT	Ritchey-Chretien	-60° 50.133'	14h 39.602m	7.13
20	JCMT	Sub-mm	-60° 50.133'	14h 39.602m	7.13
21	UKJRT	Ritchey-Chretien	-60° 50.133'	14h 39.602m	6.7
22	JCMT	Sub-mm	-60° 50.133'	14h 39.602m	6.7
23	UKJRT	Ritchey-Chretien	-60° 50.133'	14h 39.602m	6.5
24	JCMT	Sub-mm	-60° 50.133'	14h 39.602m	6.5
25	UKJRT	Ritchey-Chretien	-60° 50.133'	14h 39.602m	6.65

Data Management

- Hierachial data organization
- Project Explorer
- Password protection

Data Reduction

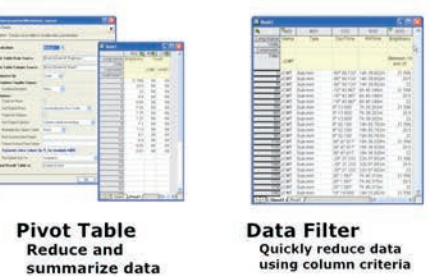

Graphing

Statistics

Analysis

→ Further processing with Origin...

Data Processing

Organizing Your Data

Origin provides an easy, flexible, and hierarchical approach to organize your data:

- The Origin Project file (.OPJ) combines data, notes, graphs, and analysis results in one document with flexible hierarchy for folder structure
- The Project Explorer window allows easy navigation within the project
- Workbooks and Matrices support multiple sheets, columns/objects, and an organizer panel for additional metadata

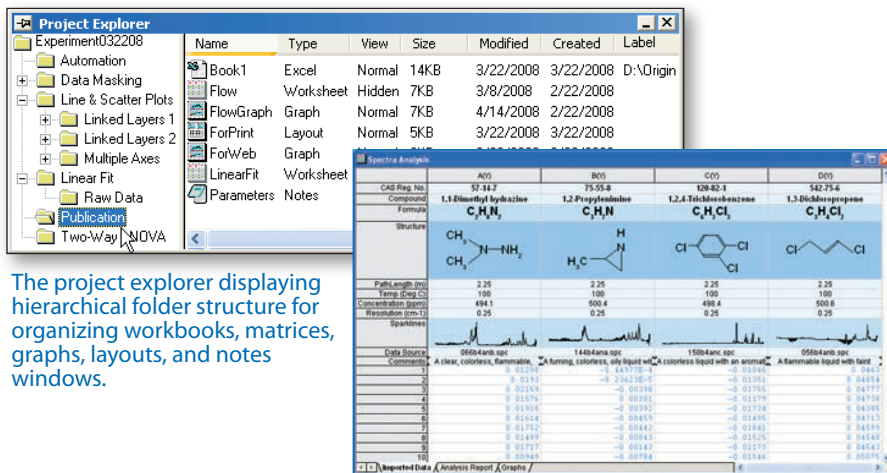

The project explorer displaying hierarchical folder structure for organizing workbooks, matrices, graphs, layouts, and notes windows.

Workbook with multiple sheets, data columns, metadata label rows, and sparklines.

Data Exploration

Origin provides easy to use tools to examine and interact with your graphical data:

Zoom and Pan

- Magnify a region of the graph
- Easily zoom and pan to desired X/Y scale
- Plot zoomed region as a separate graph

Examine Data Points and Related Data

- Customize tooltip on data point
- Use Data Reader and Screen Reader tools to examine your data
- Use Data Info tools to read or label data points, displaying the related information from other columns in the data worksheet
- Use masking tools to allow you to exclude data points from analysis
- Use the Vertical Cursor Gadget for exploring data in stacked graphs

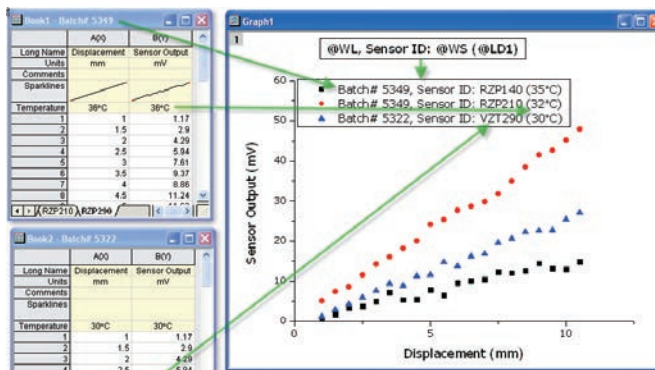

Use metadata from multiple locations in your workbook to annotate your graphs

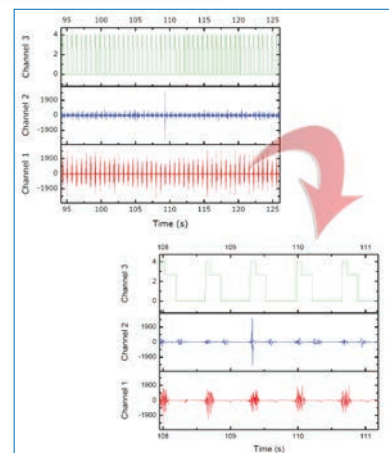

Zoom and pan to the desired X/Y scale

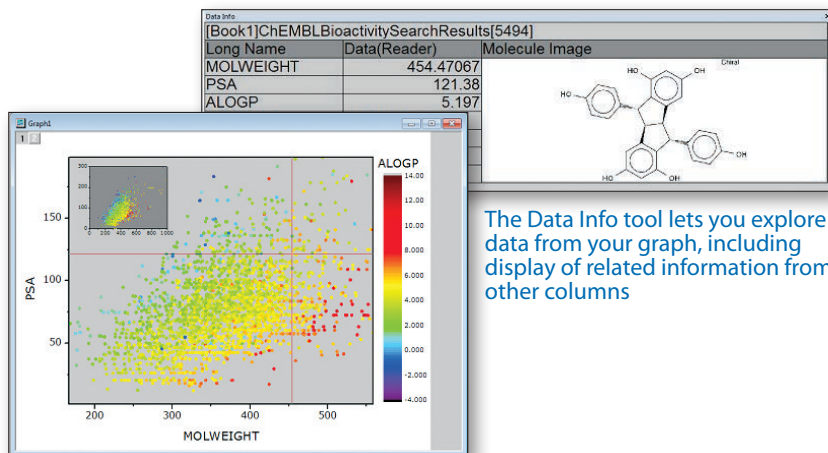

The Data Info tool lets you explore data from your graph, including display of related information from other columns

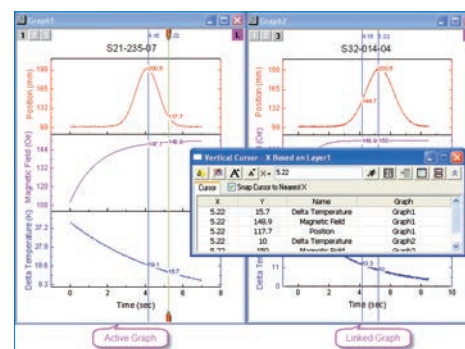

Use vertical cursor for multiple graph windows simultaneously

Data Manipulation

Reorganize, reduce, extract, and transform your data in flexible ways using Origin's powerful data manipulation tools.

Reorganization

- Sort data at column or worksheet level
- Stack and Unstack columns to transform data
- Split or Append Worksheets
- Transpose Worksheet including Metadata Rows

Transformation

- Set Column or Cell Values using Built-in or User-Defined Functions or Scripts
- Access and use Metadata, and Data from other Books and Sheets
- Shrink or Expand data in a matrix

Extraction, Reduction, and Interpolation

- Filter your data using conditions on one or more worksheet columns. All associated graphs and analysis results will automatically update.
- Use Pivot Table to reduce and summarize your data
- Reduce data using multiple methods such as Evenly Spaced X, Duplicate X, Reduce by Rows, or Reduce by Group
- Interpolate or Extrapolate data columns
- Fill data automatically in worksheet cells

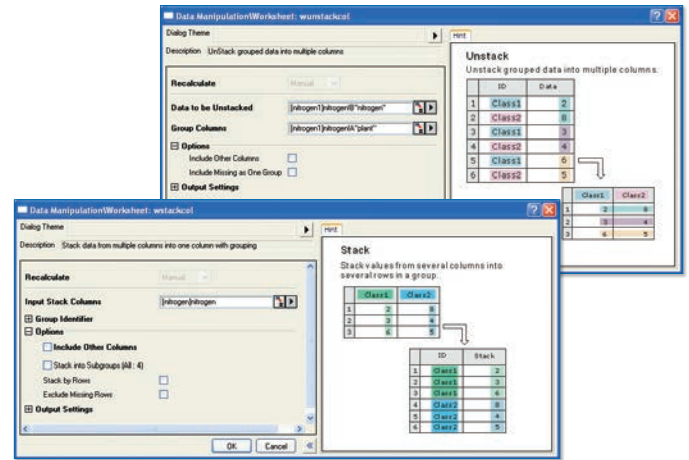

The Stack/Unstack tools enable the user to stack multiple data columns into a single column and unstack grouped data into multiple columns.

	A(X)	B(Y)	C(Y)	D(Y)
Long Name	Year	New Cases - SEER 9	Deaths - US	New Cases - SEER 9
Units		Number of Cases Per 100,000 People		No. of Cases Per 100,000
Comments		Raw Data		Yearly Change
F(x)=				$I:=17B1:B[]-B[]-1$
Mean	$=\text{mean}(\text{This})$	124.97		
Std Dev	$=\text{stddev}(\text{This})$	12.38786		
Categories	Ascending			
31	2005	126.7	24.1	-1.5
32	2006	126.4	23.6	-0.3
33	2007	128.3	23	1.9
34	2008	128.5	22.6	0.2
35	2009	130.9	22.2	2.4
36	2010	127	21.9	-3.9
37	2011	130.4	21.5	3.4
38	2012	130.1	21.3	-0.3
39	2013	130.8	20.7	0.7
40	2014	130.6	20.5	-0.2
41	Total			130.6

Using the F(x) Column Formula row in Origin (1), you can directly type expressions that calculate a column of values using data in other columns and metadata elements. You can enter cell formulas in User-defined Parameter rows (2) or in worksheet data cells (3).

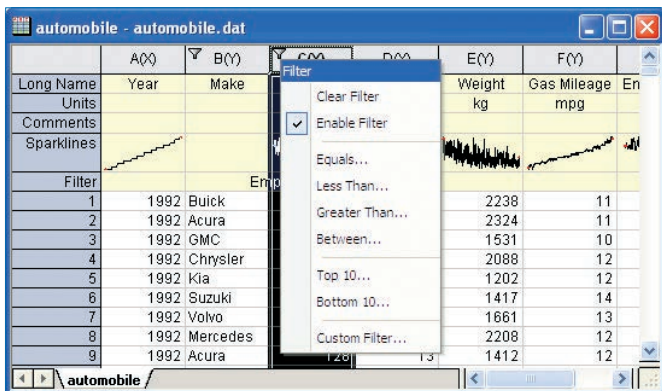

Data Filter capability can be used to hide rows based on filter conditions on columns. Hidden rows are excluded from graphing and analysis

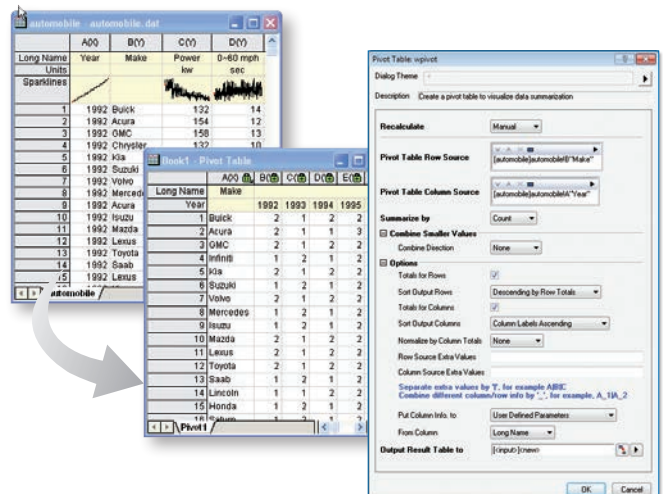

Gadgets

When your data is plotted in a graph, Origin gadgets provide a quick and easy way to perform exploratory analysis on the graph. Perform the analysis on a specific range of the data plot by appropriately positioning a region-of-interest (ROI) object to select the desired range. The ROI object provides a fly-out menu with various options that are tailored to each specific gadget. All gadgets have a fly-out menu with a Preferences option allowing you to customize desired settings.

With Origin gadgets you can:

- Select the desired data range for analysis directly from the graph
- Get immediate visual output of results
- View updated results on screen when the ROI is moved or resized
- Customize the output, including appending results to a worksheet for each ROI position
- Save settings as a Theme for repeat use
- Repeat analysis on all curves in graph layer/page

A selection of the gadgets available in Origin and OriginPro are described below. Please see other sections for additional gadgets.

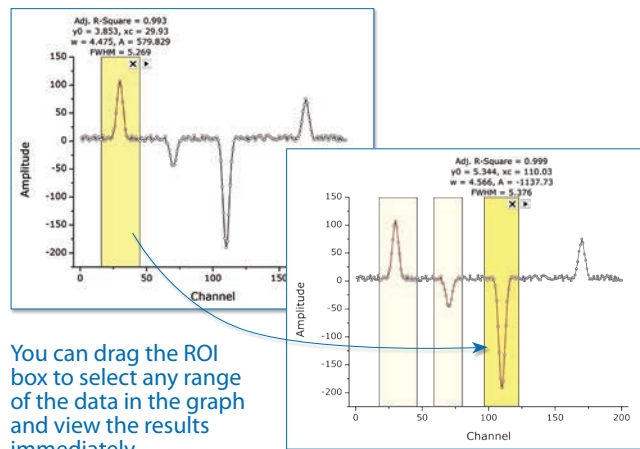

You can drag the ROI box to select any range of the data in the graph and view the results immediately

Digitizer Gadget

Extract data from images of graphs

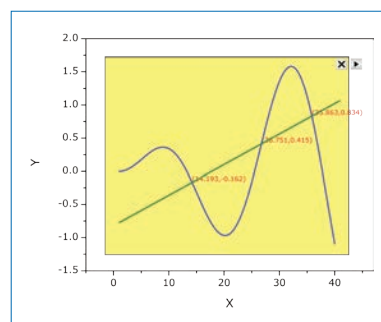
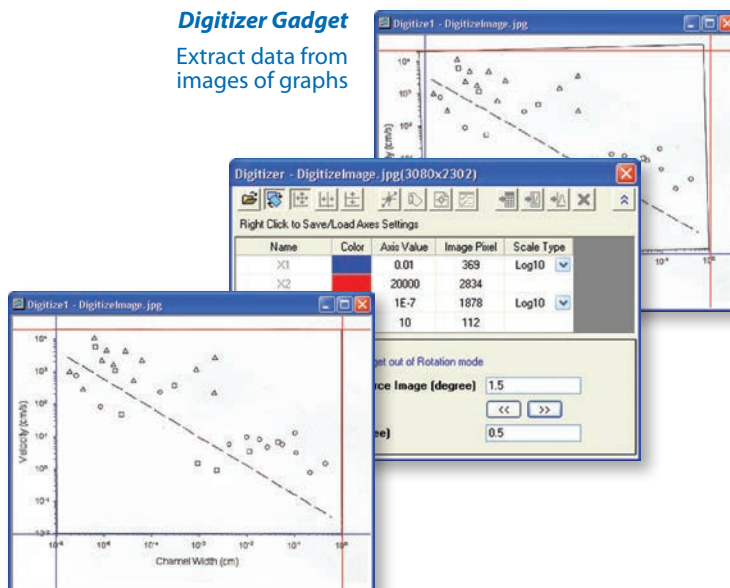

Intersection Gadget

Calculate the intersection points of the input curves

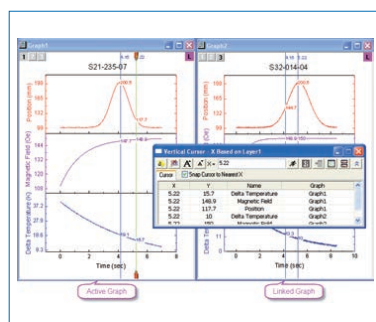

Vertical Cursor Gadget

Provides an easy way to read X and Y coordinate values for data points on stacked panel plots and/or multiple linked graphs.

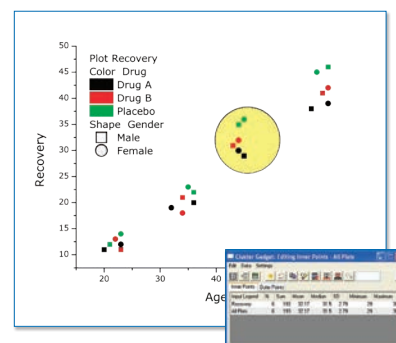

Cluster Gadget

Perform basic statistics and editing of data points within a region

“When working with many data points, graphing is often the quickest way to qualify data and identify trends. With the Origin statistics gadget, it’s also easy to pull quantitative information, such as mean and standard deviation, straight from a data plot. This lets me make better decisions about which data to select for more detailed analysis.”

Boaz Vilozny, Postdoctoral Researcher, University of California at Santa Cruz

Apps in Origin

Extend Origin's graphing and analysis capabilities by installing Apps.

The App Center dialog in Origin lets you browse available Apps or search for Apps using keywords or phrases. Install new Apps or update existing ones with a single click.

Apps are developed based on requests from Origin users.

Have a suggestion for an App?

Please contact us!

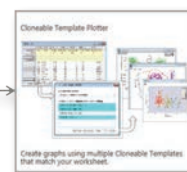
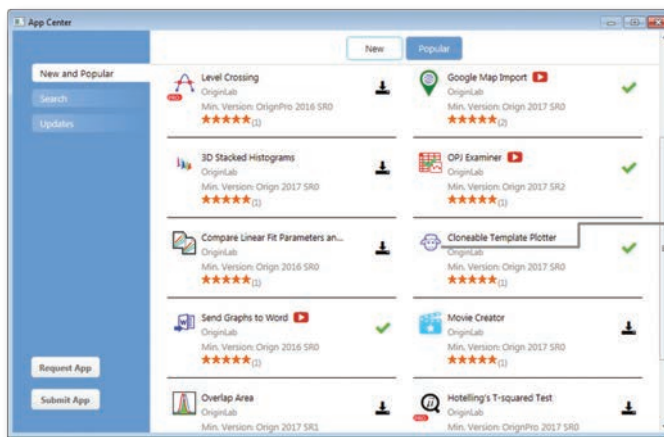

Browse for Apps, search using keywords or phrases, and install or update Apps with a single click

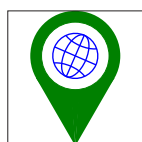

Google Map Import

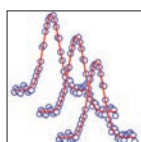

Sequential Fit

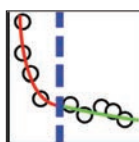

Piecewise Fit

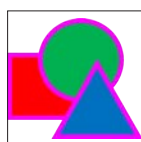
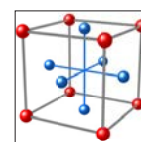

Image Object Counter



Stats Advisor



Design of Experiments



Send Graphs to PowerPoint



Graph Maker

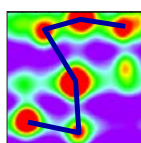

Polyline Profiles

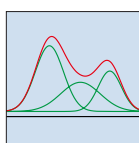

Peak Deconvolution

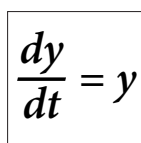

ODE Solver

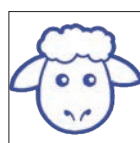

Cloneable Template Plotter

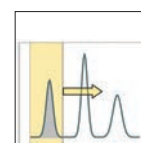

Gadget Replicator



Send Graphs to Word

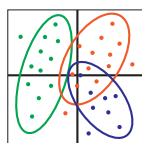

PCA

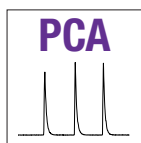

PCA for Spectra

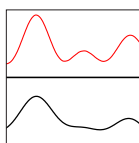

Fourier Deconvolution



LaTeX

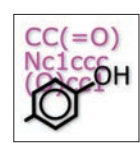

SMILES to Image

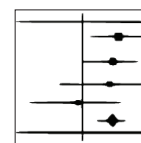

Forest Plot

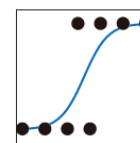

Logistic Regression

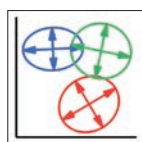

2D Confidence Ellipse

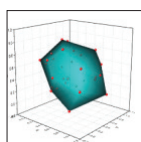

3D Convex Hull

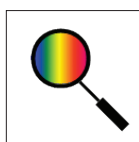

Color Editor



Cyclic Voltammetry

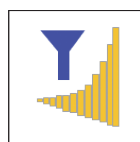

Data Slicer

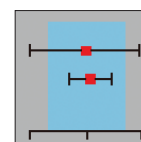

Equivalence Test

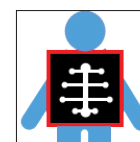

Import DICOM



Movie Creator



Import Files from a Folder



Treemap Plot

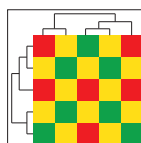

Heat Map with Dendrogram

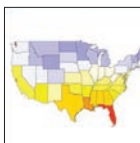

Colormap for Shapefiles

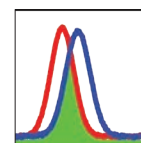

Overlap Area

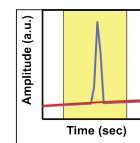

Piecewise Smooth

View more apps at originlab.com/Apps

"I am beyond pleased with the latest version of OriginPro compared to past versions that I have used. The apps provided additional features that are very helpful and useful."

Jacqueline Yim, Sr. Scientist, Advanced Development Group Aerospace, Defense & Marine, TE Connectivity

Curve Fitting

Origin provides various tools for linear, polynomial and nonlinear curve fitting. Fitting routines use state of the art algorithms and the report sheets including statistical quantities to determine goodness of fit. Create custom fitting reports and save your customization as an Analysis Template™ for repeat fitting including Batch Fitting of multiple datasets.

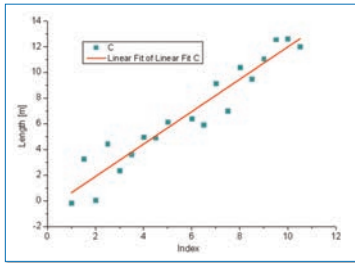

Linear

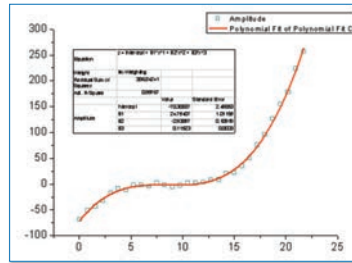

Polynomial

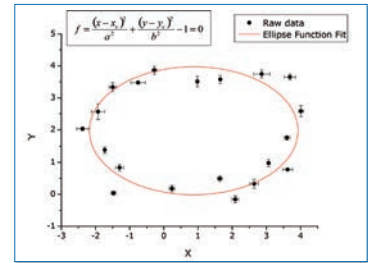

Implicit

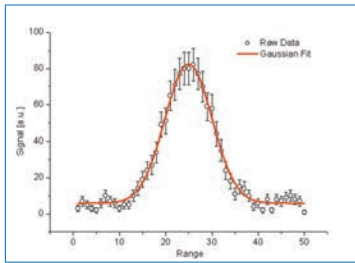

Weighted

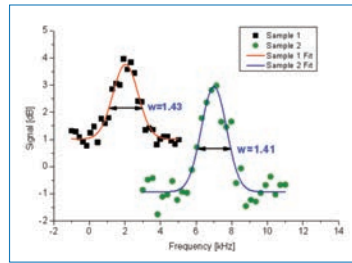

Global

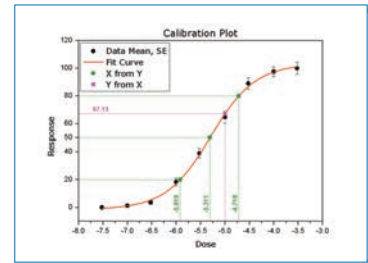

Concatenate/Replicate

Origin provides full control of the fitting process...

- Flexible data input
- Fit with various built-in functions, including both explicit and implicit
- A wizard for defining custom fitting functions
- Multi-dataset fitting modes: fit multiple datasets independently, in concatenate fit mode, or use a global fit with shared parameters
- Fit statistics and parameters output to the fit report
- Residuals analysis
- Interpolation on the fit curve to compute new X/Y values at desired locations
- Recalculation of your fitting results automatically when data or parameters are changed
- Analysis Templates™ to save your settings and desired results for repeat use or batch processing
- Iteration Algorithms: Levenberg-Marquardt and Orthogonal Distance Regression (Pro)

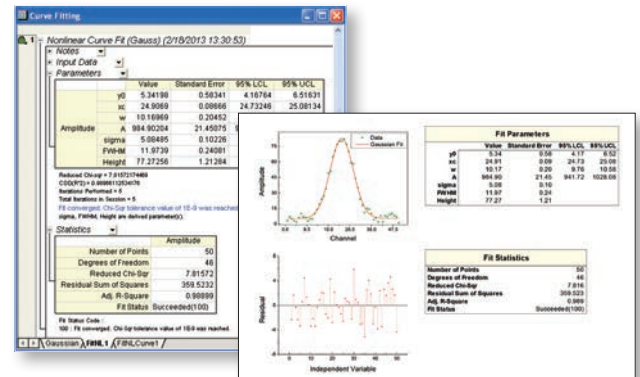

Use Origin's fit report sheets, or easily create custom reports by combining graphs and numerical results from the fitting process

Fit Comparison PRO

OriginPro provides the following tools for fit comparison:

- Compare two fitting models with dataset
 - F-test
 - Akaike's Information Criterion (AIC) test
- Compare one fitting model with two datasets
 - F-Test
- Fit dataset with multiple models and rank fit results using AIC /BIC test

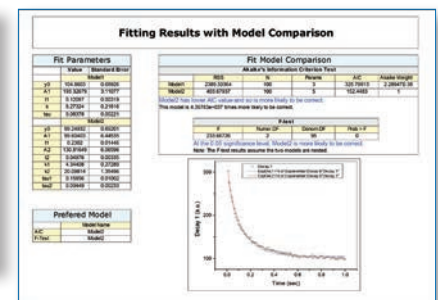
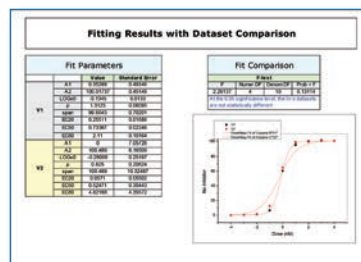

"Not only does Origin handle the most demanding curve fitting tasks with ease, it also has a built in C compiler that allows me to customize complex functions - a feature that has been crucial to my research. Origin is an indispensable tool to my grad students, whose PhD work hinges on being able to code our functions in C. To top it off, Originlab has a knowledgeable and responsive technical support staff, second to none. I wholeheartedly recommend Origin."

Mark Kuzyk, Ph.D., Regents Professor of Physics and Astronomy, Washington State University

Quick Fit Gadget

Origin provides a simple tool to quickly fit data plotted in a graph. Move or resize a region of interest (ROI) object to update results. Interactively perform fit operations on multiple ranges of the same dataset, or on multiple datasets in the graph.

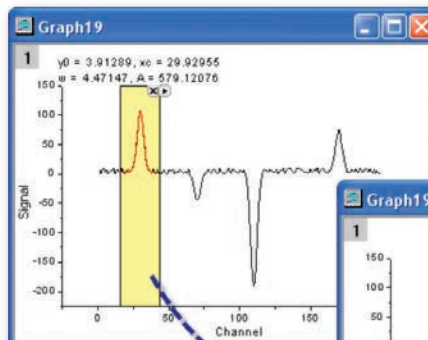

You can drag the ROI box to fit any sub range of the curve in the graph. Fit results displayed on the graph update immediately

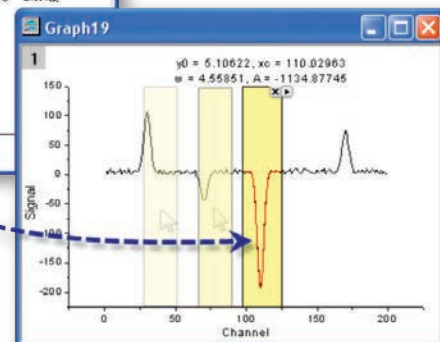

Fit parameters and other key values can be output directly to the graph or to a worksheet

Long Name	Function	Input	Range	Weighting	E(Y)	F(YErz)	G(Y)	H(YErz)	I(Y)	J(YErz)
Units					y0	y0-Error	xc	xc-Error	w	w-Error
1	Gauss	Signal	[154:181]	No Weighting	4.56663	0.68765	170.00289	0.0641	4.64227	0.14407
2	Gauss	Signal	[141:168]	No Weighting	5.4106	0.58756	169.1392	1.31362	3.82151	1.20206
3	Gauss	Signal	[96:123]	No Weighting	5.40797	0.56778	110.02963	0.01825	4.56804	0.0409
4	Gauss	Signal	[61:88]	No Weighting	4.32127	0.60784	70.15248	0.07754	4.61447	0.17405
5	Gauss	Signal	[16:43]	No Weighting	3.91289	0.71431	29.92955	0.04407	4.47147	0.09838
6	Gauss	Signal	[157:184]	No Weighting	4.49203	0.65383	170.00288	0.06091	4.6491	0.13693
7										

"The new Quick Fit Gadget is fantastic and I absolutely love that I can output results to a worksheet so that I can get a column of a particular parameter on which I can do statistical analysis."

Greg Scott, University of Illinois at Urbana-Champaign

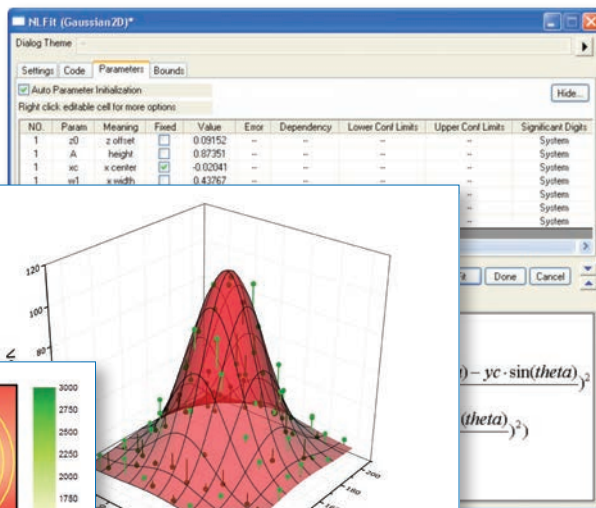

3D Surface Fitting PRO

Origin performs 3D surface fitting on XYZ worksheet data and matrix data using one of 19 built-in models or your own custom formula.

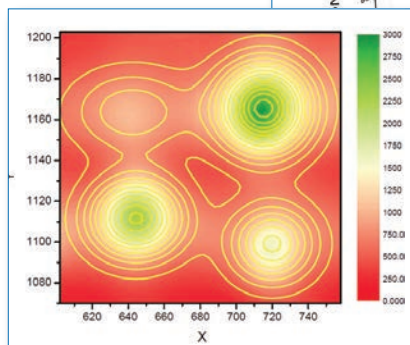

Contour plot displaying raw data and fit results from a 4-peak surface fit

Data points and fit surface are shown together. The fit surface has been made transparent to show more of the data. Drop lines from the data points to the surface have been added

Peak Analysis

Origin's Peak Analyzer is a powerful and versatile tool for peak and baseline detection and analysis.

- A wizard guides you through the fitting process
- Find and treat the baseline, find and select peaks, integrate peaks
- Generate a detailed report sheet with tables and relevant graphs
- Generate a worksheet with peak properties, including FWHM, centroid, area, peak index, and y-max

The additional features of peak fitting and baseline fitting described below are only available in OriginPro.

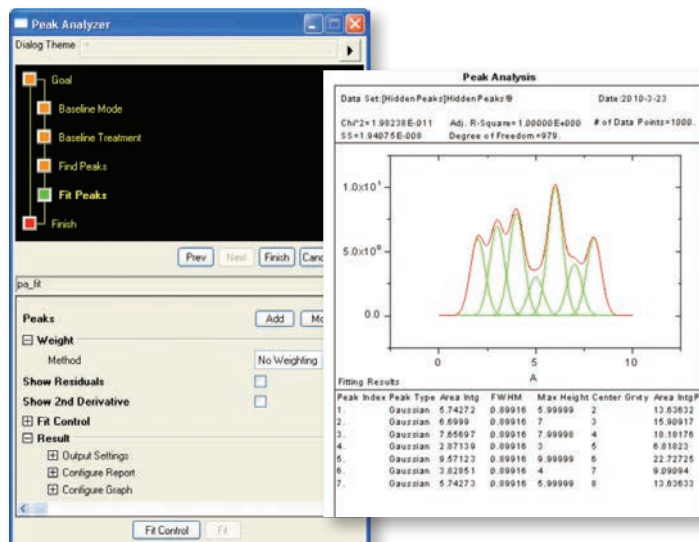

Multi-peak fitting with a detailed report

Peak Fit Control PRO

When using the Peak Analyzer to fit peaks, many options are available to customize your analysis.

- Add, delete or adjust the position of peaks directly on the graph
- Assign the same fitting function to all peaks, or use different fitting functions for each peak, or group of peaks
- Fix peak parameters to a constant value
- Share parameters across peaks
- Apply bounds and linear constraints to fitting parameters
- Plot residuals and second derivative of the fit curve
- Use over 20 built-in peak functions—including Gauss, Voigt, and Lorentz—or create your own

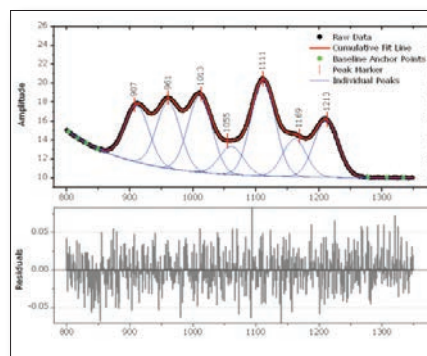

Control the fitting process directly on the graph

With the Peak Fit Parameters dialog, you have full control of the fitting parameters

Share a common parameter between peaks, fix the value of any parameter, or apply bounds. Right-click on a parameter value to share it with other peaks in the fitting operation

NO.	Peak Type	Param	Meaning	Share	Fixed	Value	Error	Dependency	Significant Digits	Lower Bound
0	Constant	y0	unknown	0	<input checked="" type="checkbox"/>	0.7	0	0	System	--
1	Lorentz	xc_1	center	0	<input type="checkbox"/>	1.00016	0.0362	8.4325E-4	System	--
1	Lorentz	w_1	FWHM	1	<input type="checkbox"/>	0.42666	0.11958	0.63425	System	0
1	Lorentz	A_1	area	2	<input type="checkbox"/>	82.85819	19.63085	0.74389	System	--
2	Gaussian	xc_2	center	0	<input checked="" type="checkbox"/>	4	0	0	System	--
2	Gaussian	A_2	amplitude	0	<input type="checkbox"/>	119.84023	11.9359	0.41196	System	--
2	Gaussian	w_2	FWHM	0	<input type="checkbox"/>	0.75756	0.0836	0.36139	System	0
3	Gaussian	xc_3	center	0	<input type="checkbox"/>	5.98962	333535.65745	0.52358	System	--
3	Gaussian	A_3	amplitude	1	<input type="checkbox"/>	0.42666	0.11958	0.63425	System	0
3	Gaussian	w_3	FWHM	2	<input type="checkbox"/>	82.85819	19.63085	0.74389	System	--

Fitting a Baseline PRO

OriginPro not only fits peaks, but can fit a function to your baseline data as well. The following options allow flexibility in fitting your baseline:

- Select baseline anchor points, or have Origin automatically find them
- Fit baseline anchor points using a pre-defined fitting function, or create your own
- Fix the baseline anchor points, or allow them to vary with the peak fit
- Subtract the baseline prior to fitting peaks

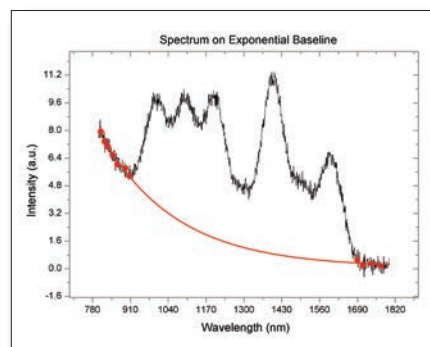

Fit a baseline to an exponential function using anchor points

"When the signal is small compared to the baseline noise, baseline subtraction is tough. In Origin, it was incredibly easy to create a test baseline (picking anchor point manually by clicking on the graph). Once we found the best baseline, we could process multiple data sets automatically. You just can't do this with any other software."

Rosina Georgiadis, Associate Professor, Chemistry Department, Boston University

Quick Peaks Gadget

The Quick Peaks Gadget provides a simple and quick way to perform peak analysis of plotted data within a ROI.

With this gadget, you can:

- Locate positive and negative peaks
- Define baseline and subtract from the spectrum
- Integrate peaks within base markers
- Perform peak fitting with frequently used functions
- Create a report sheet with parameters from each peak
- Repeat analysis on all curves in graph layer/page

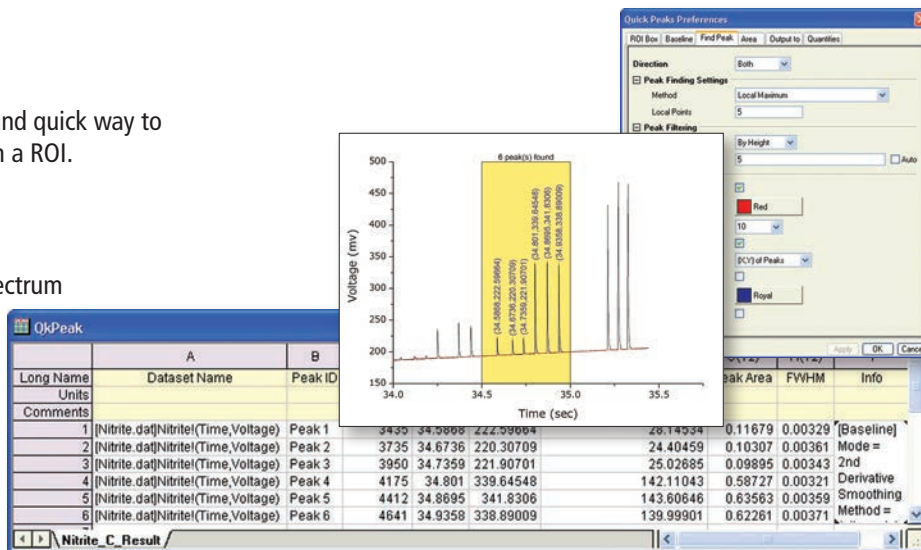

Create baseline, find Peaks, integrate peaks and output results

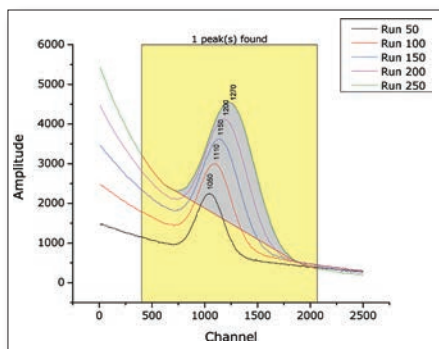

Long Name	Dataset Name	Peak X	Peak Y	Height	Peak Area	FWHM
1 [Book1]Sheet1(Channel,Run 50)		1050	2256.26	1448.87	427194.41	281.24
2 [Book1]Sheet1(Channel,Run 100)		1110	3001.70	1886.80	663346.59	337.59
3 [Book1]Sheet1(Channel,Run 150)		1150	3622.68	2281.05	911256.43	390.05
4 [Book1]Sheet1(Channel,Run 200)		1200	4120.82	2687.46	1.23E+06	444.26
5 [Book1]Sheet1(Channel,Run 250)		1270	4503.64	3047.02	1.56E+06	492.52

Plot multiple curves, use the Quick Peaks Gadget to set preferences such as baseline on one curve, then generate a report.

Batch Peak Integration on multiple curves.

Batch Peak Fitting PRO

With batch peak fitting, OriginPro can handle many datasets, each containing multiple peaks.

- Perform batch peak fitting using a pre-defined theme, an Analysis Template™, or script
- Output a custom report of peak parameters for each peak in each dataset

Dataset Name	Peak Index	Peak Type	Area Fit	Area FWHM	Area FWHM	Center Max	Center Grid	Max Height	FWHM
XJ-406 Trial #2	1	Gaussian	56.1634	37.25856	17.6942	6.65458	6.65458	1.67753	31.45
XJ-406 Trial #2	2	Gaussian	149.20413	149.11429	70.81483	25.61793	25.61793	8.33608	16.81
XJ-406 Trial #2	3	Gaussian	6.67886	4.03902	1.91614	38.18798	38.18798	0.10413	60.2
XJ-406 Trial #2	4	Gaussian	29.0945	20.15742	9.57282	47.26143	47.26143	2.13561	12.79
SJ-581 Trial #7	1	Gaussian	60.34625	60.34158	100	20.045	20.045	4.7823	11.85
AD-679 Trial #3	1	Gaussian	4.36173	2.94201	16.17467	6.52203	6.52203	0.14271	28.71
AD-679 Trial #3	2	Gaussian	14.69009	14.68388	80.72953	25.94682	25.94682	0.84512	16.32
AD-679 Trial #3	3	Gaussian	1.73772	0.56309	3.0958	52.98028	52.98028	0.10544	15.44
LP-215 Trial #1	1	Gaussian	155.48256	112.86122	30.08914	4.99583	4.99583	9.23222	15.6
LP-215 Trial #1	2	Gaussian	0.10299	0.10299	0.02747	8.25062	8.25062	0.03736	2.58
LP-215 Trial #1	3	Gaussian	30.8482	30.8482	8.22668	13.99901	13.99901	4.9718	5.82306
LP-215 Trial #1	4	Gaussian	28.94503	28.94503	7.71914	26.0014	26.0014	4.98338	5.45654
LP-215 Trial #1	5	Gaussian	15.86715	15.86715	4.23149	29.00948	29.00948	2.08907	7.13531
LP-215 Trial #1	6	Gaussian	10.65875	10.65875	2.8425	33.98893	33.98893	1.91434	5.23064
LP-215 Trial #1	7	Gaussian	235.78533	175.69411	46.85458	43.00029	43.00029	8.86134	24.99683

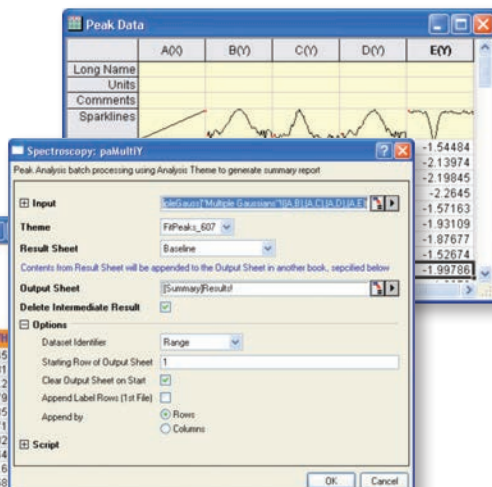

Perform peak fitting on multiple datasets using a pre-defined theme; output the results to a customized worksheet

Signal Processing

Signal Transforms

Origin provides several transform methods used for analyzing digital signals.

- Fast Fourier Transform and Inverse Fast Fourier Transform (FFT/IFFT)
- Short-time Fourier transform (STFT) **PRO**
- Hilbert Transform **PRO**
- 2D FFT/2D IFFT **PRO**
- Image Profiling: Simple Line Profiling: Horizontal, Vertical, raight Line

Filtering

- FFT Filter:
 - Low Pass, High Pass, Band Pass, Band Block, Noise Threshold
- IIR Filter Design **PRO**
 - Butterworth, Chebyshev Type I, Chebyshev Type II, Elliptic
- 2D FFT Filter **PRO**

Smoothing

Origin offers multiple methods to smooth data

- Savitzky-Golay
- Adjacent-Averaging
- FFT Filter
- Percentile Filter
- Lowess and Loess

Correlation

Origin supports 1D and 2D correlation to detect the correlation between a pair of signals

- Correlation
- 2D Correlation **PRO**

Convolution/Deconvolution

Two types of Convolution and deconvolution are supported

- Linear
- Circular

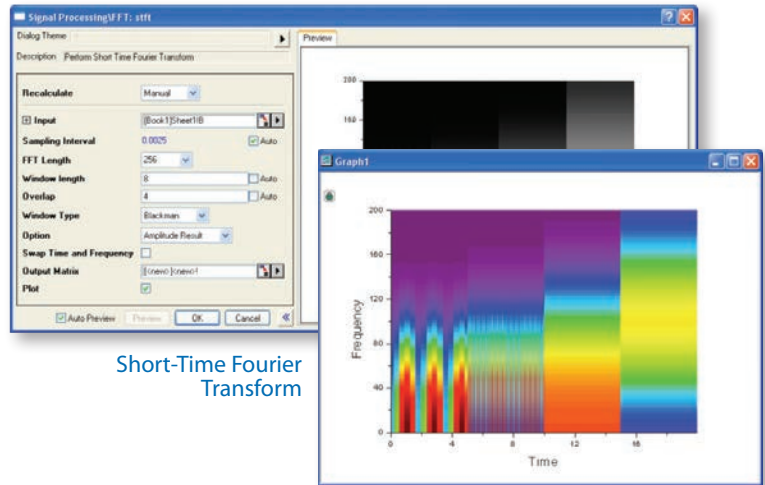

Short-Time Fourier Transform

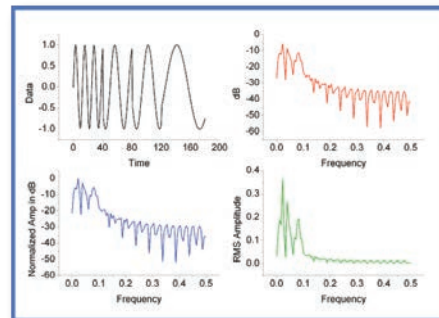

Results of FFT, including original signal and results in frequency domain

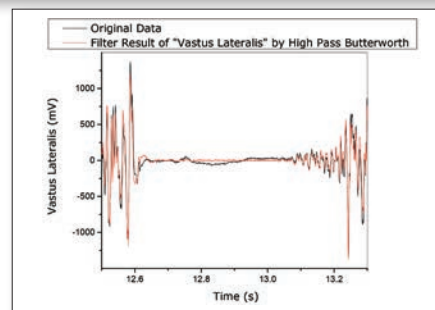
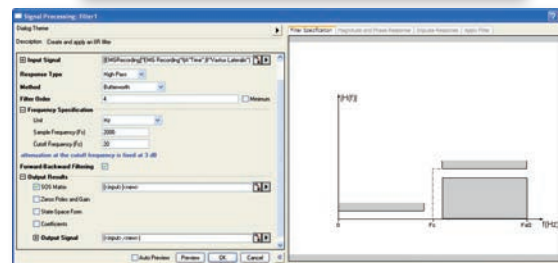

IIR Filter Design Dialog and Result

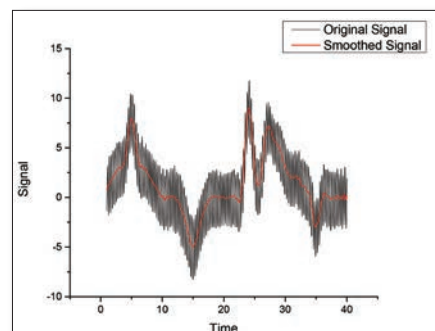

Smoothing

Wavelet Analysis **PRO**

Wavelet Transforms are used in many applications, including data compression, signal smoothing, noise removal, and image analysis. Wavelet analysis tools include:

- Continuous Wavelet Transform
- Discrete Wavelet Transform – (Decomposition)
- Inverse Discrete Wavelet Transform – (Reconstruction)
- Multi-Scale Wavelet Decomposition
- Smoothing
- Noise Removal
- 2D Wavelet Decomposition
- 2D Wavelet Reconstruction

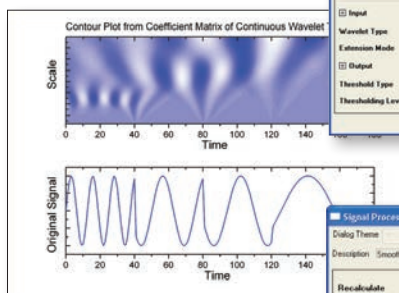

Continuous Wavelet Transform

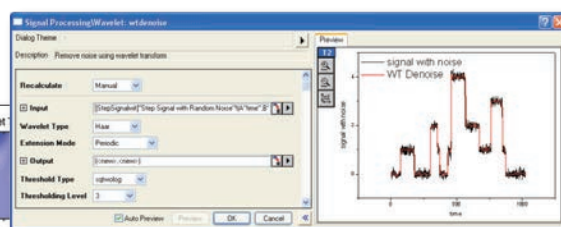

Remove Noise Using Wavelet Transform

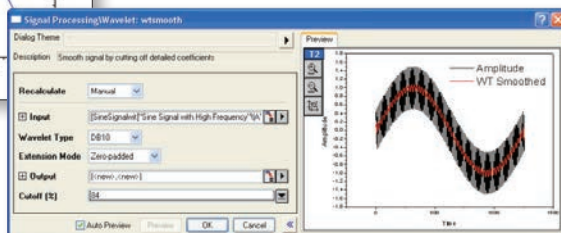

Wavelet Smoothing

Rise Time Gadget **PRO**

Three methods of finding the rise/fall time are supported:

- Linear search
- Histogram
- Largest triangle
- Select a specific region of the signal by moving and resizing a region of interest (ROI)
- Easily select desired data plot from the graph layer with multiple plots
- Display low and high levels inside the ROI control
- Display rise/fall time and rise/fall range on top of ROI

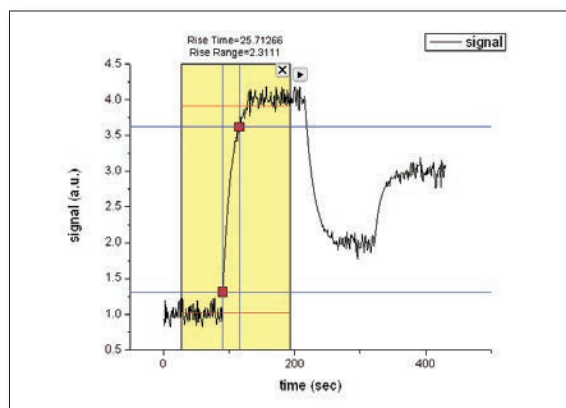

Rise Time Gadget

Decimation **PRO**

Decimation is used to reduce the number of elements in an input sequence. Every N samples are merged into one. Two filters are available:

- Moving Average
- Finite Impulse Response (FIR)

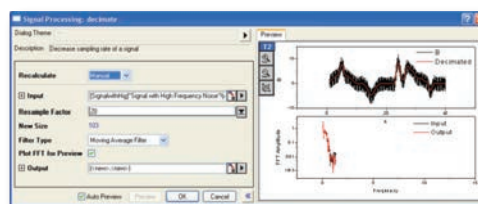

Decimation on Signal with High Frequency Noise

Coherence **PRO**

Coherence—the degree of linear dependency of two signals—is evaluated by testing whether the signals contain similar frequency components.

Envelope Curves **PRO**

An envelope curve traces the crests and troughs of a periodic signal.

- Choose upper, lower or both
- Smoothing option during envelope detection

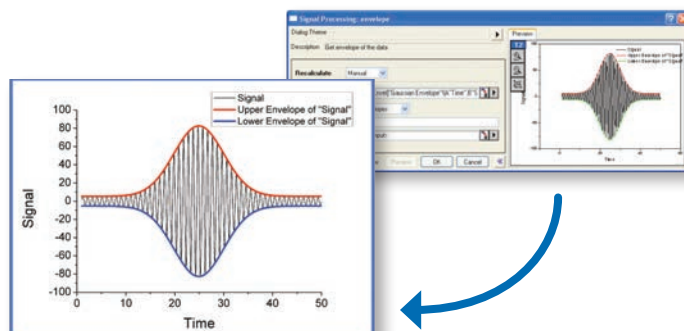

Envelope Curves

Statistics

Descriptive Statistics

Origin provides tools to help you summarize your continuous and discrete data:

- Statistics on Columns
- Statistics on Rows
- Cross Tabulation **PRO**
- Frequency Counts
- 2D Frequency Count/Binning
- Discrete Frequency
- Normality Test
- Distribution Fit **PRO**
- Correlation Coefficient **PRO**
- Partial Correlation Coefficient **PRO**

Parametric Hypothesis Tests

Seven hypothesis tests for mean and variance are available:

- One-Sample t-Test
- Two-Sample t-Test
- Pair-Sample t-Test
- Two-Sample t-Test on Rows **PRO**
- Pair-Sample t-Test on Rows **PRO**
- One-Sample Test for Variance **PRO**
- Two-Sample Test for Variance **PRO**
- One-Sample Proportion Test **PRO**
- Two-Sample Proportion Test **PRO**

ANOVA

Origin provides 5 ANOVA tools to examine the variance of a dependent variable:

- One-Way ANOVA
- Two-Way ANOVA
- Three-Way ANOVA **PRO**
- One-Way Repeated-Measures ANOVA **PRO**
- Two-Way Repeat'd-Measures ANOVA **PRO**

Survival Analysis **PRO**

Choose from three widely used survival analysis functions:

- Kaplan-Meier product-limit estimator, with three equality test methods
 - Log-rank
 - Breslow
 - Tarone-Ware
- Cox Proportional Hazards Model
- Weibull Fit Model

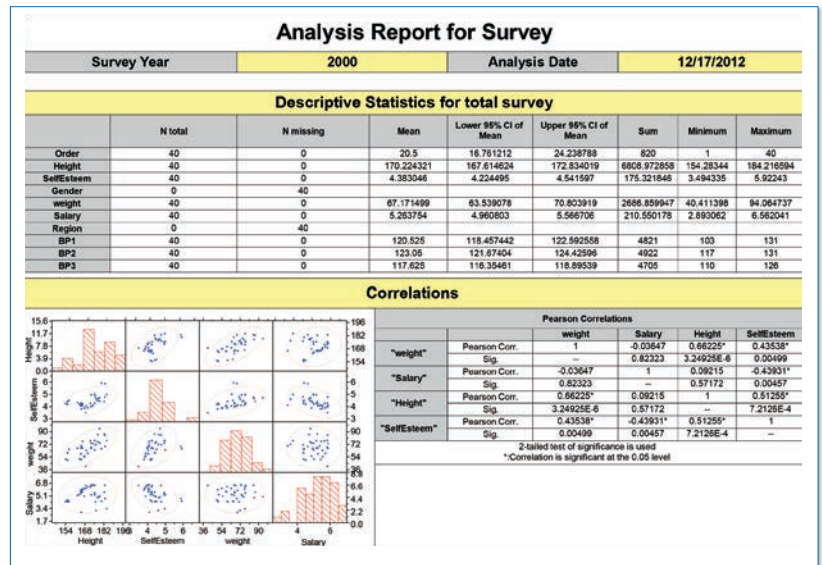

Custom report to automate your statistical analysis tasks

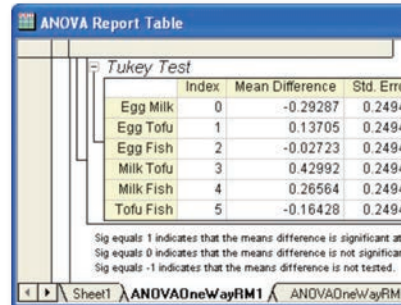

Means-comparison table, means plot, and mean-comparison plot in an ANOVA

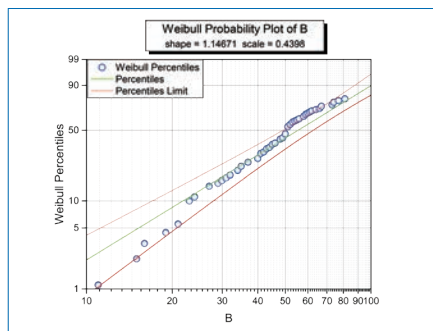
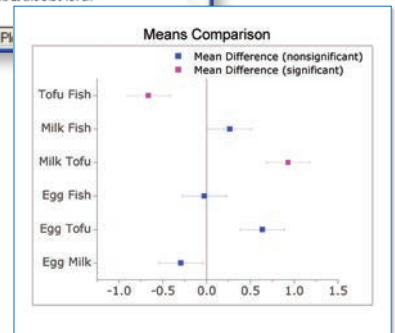
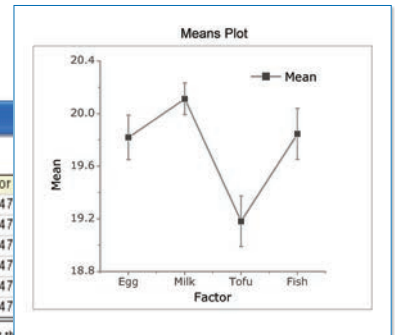

Survival Function Plot and Probability Plot of Weibull Fit

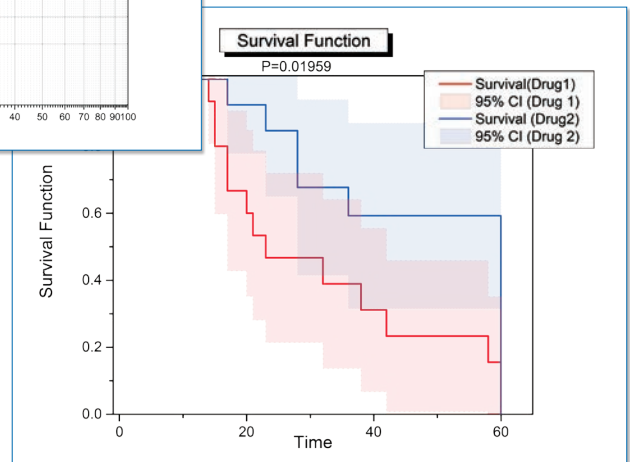

“OriginPro provides a very powerful, comprehensive and useful range of statistics capabilities which go beyond what is offered in many statistical packages. OriginPro’s ANOVA techniques include all important multiple comparisons tests for means, and a very useful output feature which is rarely found in other statistical packages: automatic creation of means comparison plots which will illustrate significant differences at a glance. A broad range of non-parametric tests is available which include the option of calculating exact p-values based on the exact distribution instead of the asymptotic one, which is very important for small sample size. Also sample size and power calculations are supported.”

Reinhard Bergmann, PhD, Novartis Institutes for Biomedical Research

Nonparametric Tests **PRO**

Several nonparametric tests are available, including:

- One-Sample Wilcoxon Signed Rank
- Paired-Sample Sign
- Paired-Sample Wilcoxon Signed Rank
- Two-Sample Kolmogorov-Smirnov
- Mann-Whitney
- Kruskal-Wallis ANOVA
- Mood’s Median
- Friedman ANOVA

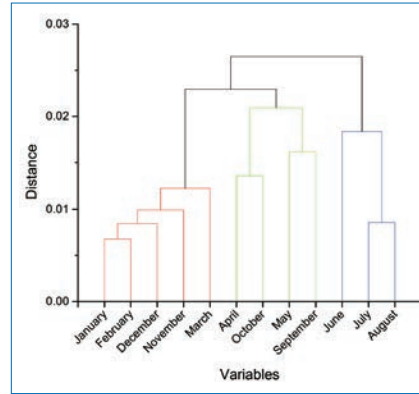

Dendrogram and Loading Plot in Multivariate Analysis tools

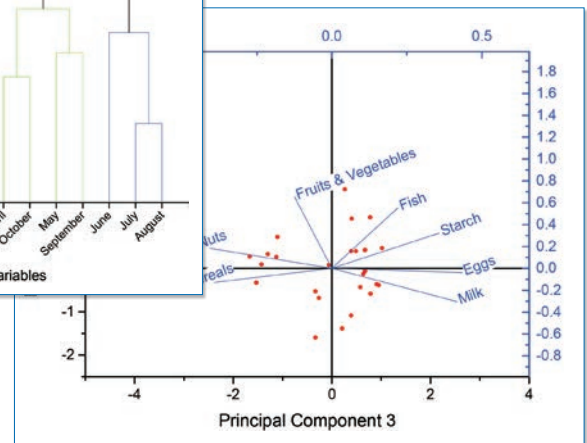

Multivariate Analysis **PRO**

Five commonly used multivariate tools are available:

- Principal Component Analysis
- K-Means Cluster
- Hierarchical Cluster
- Discriminant Analysis
- Partial Least Square

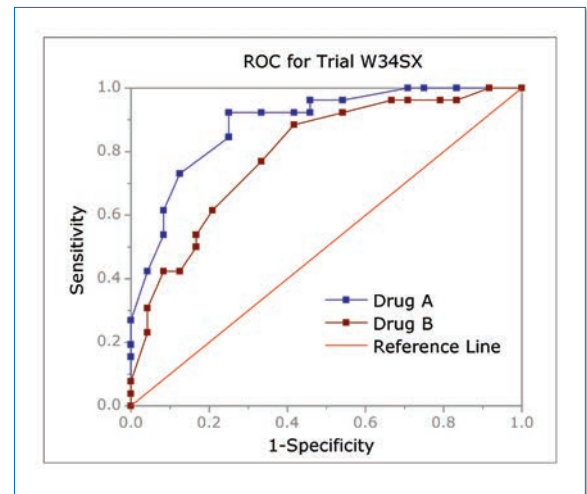

ROC curve comparing two samples

ROC Curves **PRO**

Create Receiver Operating Characteristic (ROC) Curves, summarizing the trade-off between the false-positive and true positive rates for all possible cutoff values.

Power and Sample Size **PRO**

- One-Sample t-Test
- Two-Sample t-Test
- Pair-Sample t-Test
- One way ANOVA
- One-Proportion Test
- Two-Proportion Test
- One-Variance Test
- Two-Variance Test

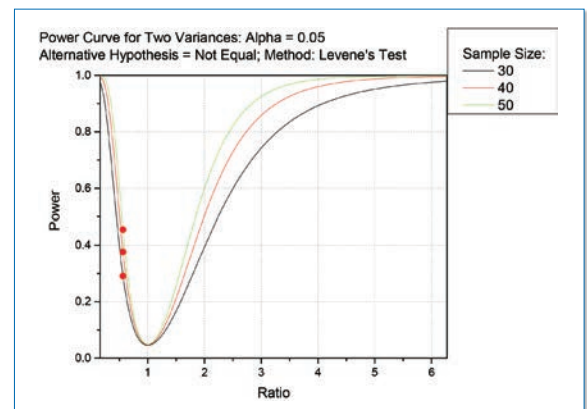

Handling Repetitive Tasks

Graph Template

Templates allow you to quickly create consistent-looking graphs. They also provide a starting point for creating your own set of graph customizations.

Graph Theme

Graph themes can be applied to any graph at any time, thus changing various object properties such as layer size, page color, plot symbol type and color.

Copy and Paste Formats

Copy and paste formatting from one plot to another, to quickly set properties of individual elements or all objects in the graph.

Batch Plotting

Origin supports batch plotting. If you have several workbooks, worksheets or columns with similar data, you can create one graph and then duplicate that graph using other data.

- Duplicate graph with new sheets/books
- Duplicate graph with new columns

Smart Plotting with Cloneable Graph Templates

Worksheet column to graph layer associations are saved in template, allowing for one-click creation of graphs from sheets with similar data structure.

- Mark a graph template as Cloneable Template
- New Template Library for User-defined Graph Templates only

2000 - 2004					
	A(X1)	B(Y1)	C(Y1)	D(X2)	
Long Name	Year	Make	Weight	0-60 mph	
Units			kg	sec	

1992 - 1999					
	A(X1)	B(Y1)	C(Y1)	D(X2)	
Long Name	Year	Make	Weight	0-60 mph	
Units			kg	sec	
1	1992	Buick	2238	14	
2	1992	Acura	2324	12	
3	1992	GMC	1531	13	
4	1992	Chrysler	2088	10	
5	1992	Kia	1202	12	

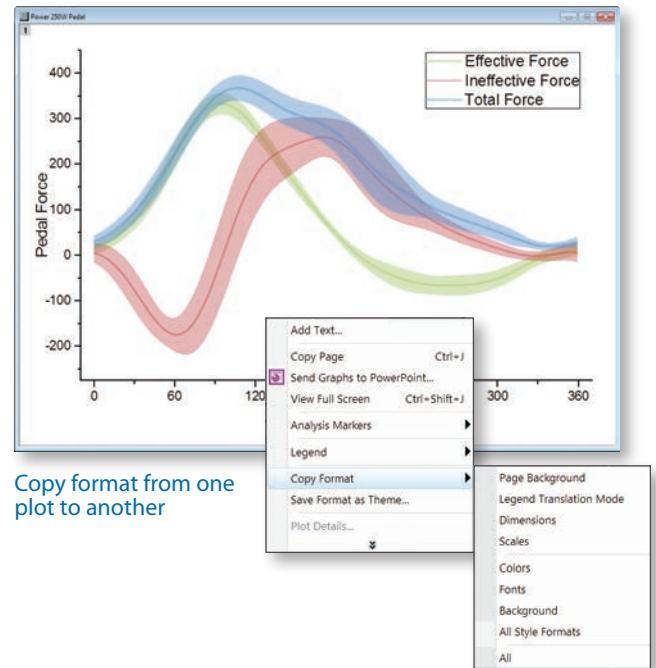
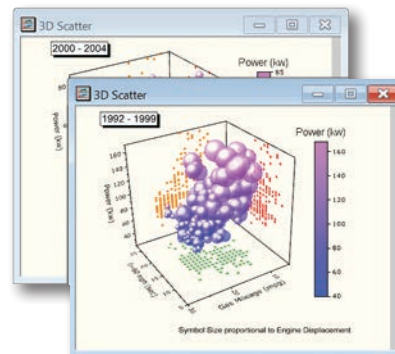

Copy format from one plot to another

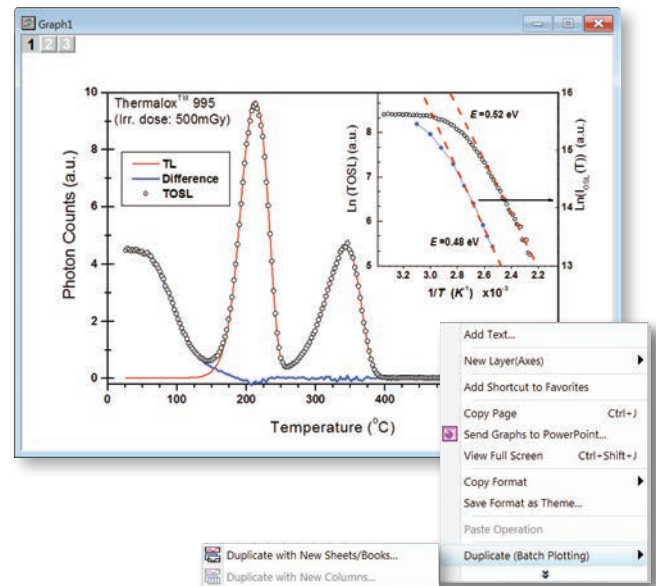

Recalculation of Analysis Results

Origin supports automatic or manual recalculation of results for most analysis and data processing operations.

This allows you to:

- Perform the same analysis on other datasets by replacing data
- Update existing results by changing analysis parameters

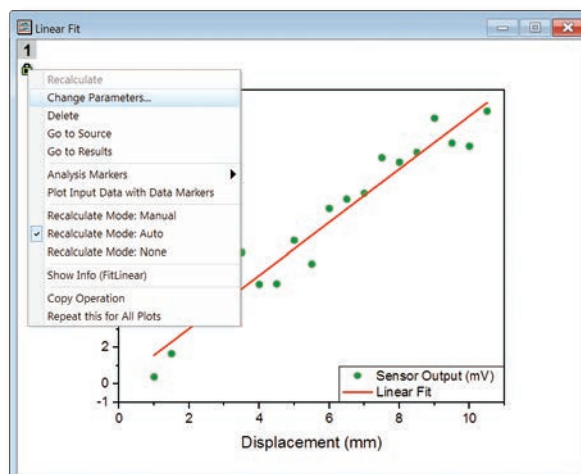

The “Change Parameters...” menu item allows you to re-open a dialog and change analysis parameters to update the analysis

Clone Workbook during Batch Import

Origin provides a quick yet powerful way to allow user perform batch analysis when importing multiple files.

- Import one file and set up your workbook with desired analysis and graphs all contained within the book
- Import a set of new files, and simply ask for the active workbook to be cloned for each new file

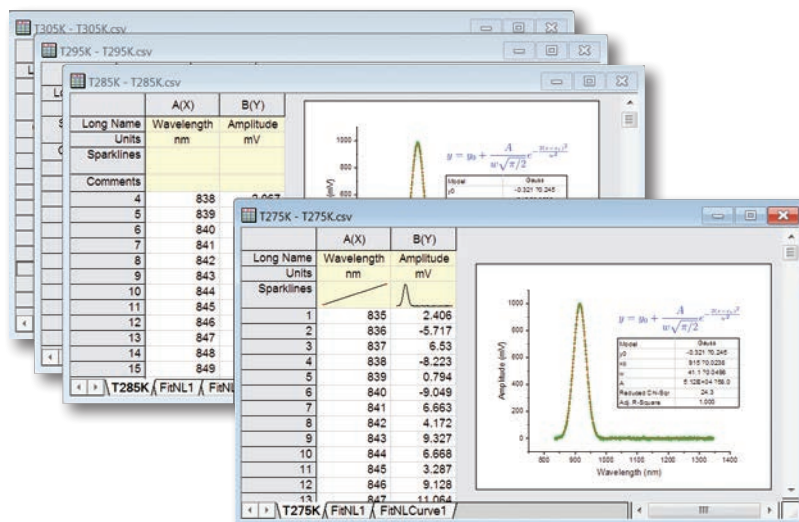
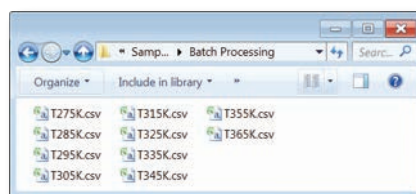

Import multiple data files into cloned workbooks to perform batch processing

Handling Repetitive Tasks *(continued...)*

Repeat Operation on All Plots or Columns

Once you perform an operation on a data plot or a worksheet column, Origin allows you to repeat that operation for all other plots in the graph, or all other columns in the worksheet.

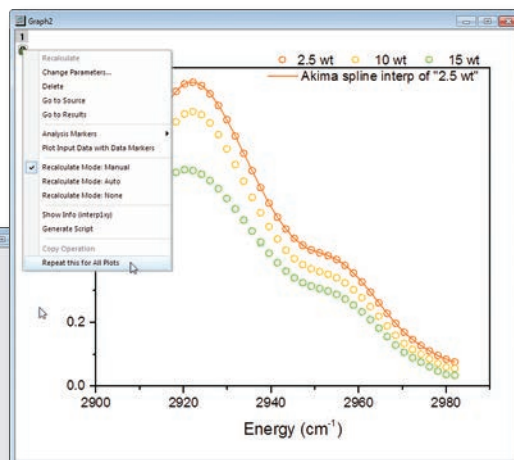
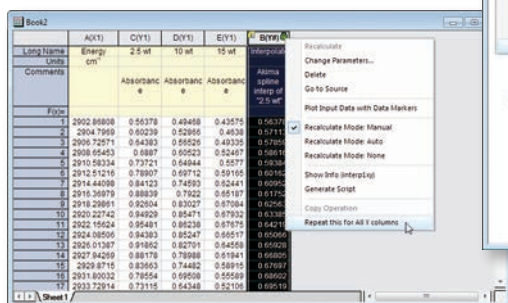

Copy & Paste Fitting Operation

Once you perform curve fitting on one data plot, you can simply copy and paste that operation on other selected curves in the same graph or on other graphs.

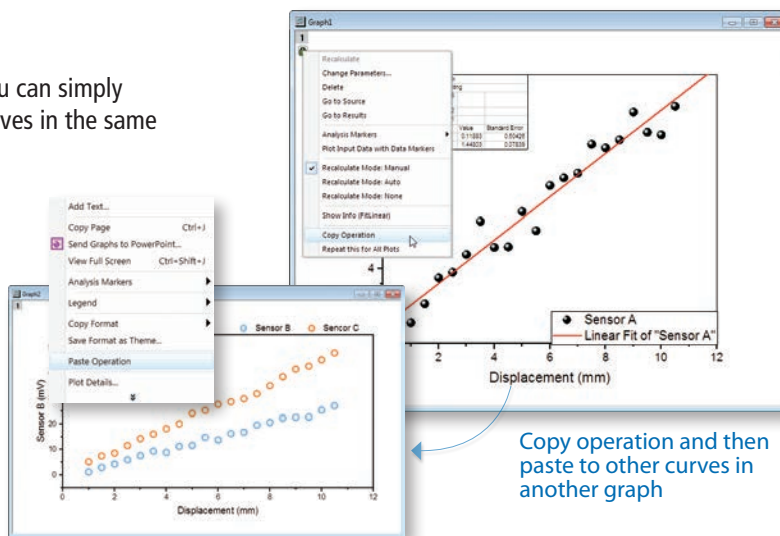

Copy operation and then paste to other curves in another graph

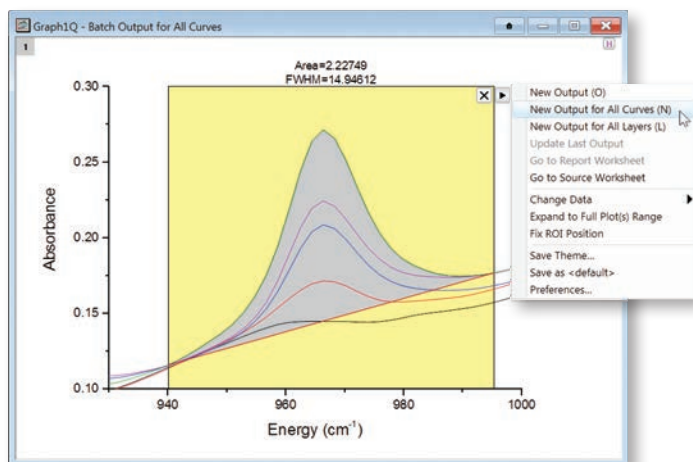

Use Gadgets for Analyzing Multiple Curves

Origin supports performing repetitive analysis on multiple data plots using Gadgets.

Analysis Templates™

Origin's ability to recalculate results on parameter or data change, can be used to create Analysis Templates™ for repeat analysis.

Analysis Templates™ can be a single workbook or an entire Origin project. Import data, perform analysis, and optionally create custom report sheet combining graphs and results. Save the book or project as an Analysis Template™, and then re-use to analyze similar data.

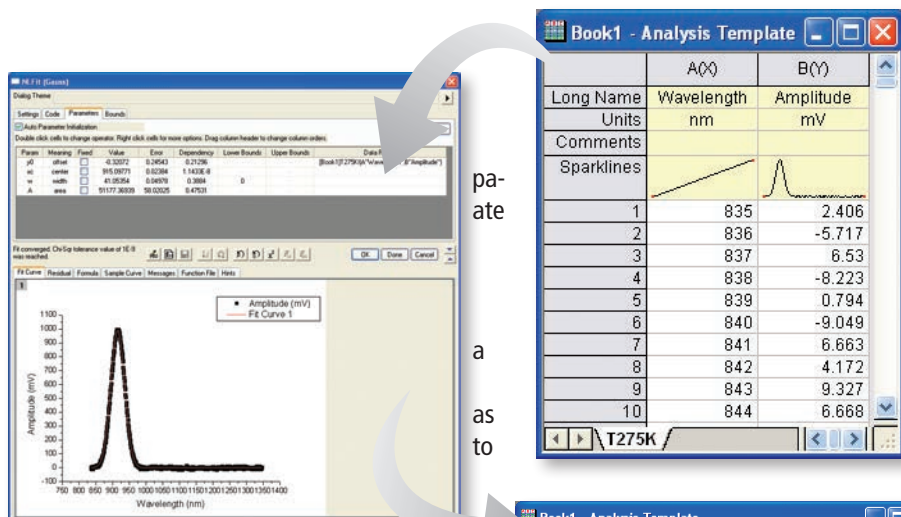

Set up your analysis the way you want. After your initial analysis has completed, just save the workbook as an Analysis Template™

Batch Processing

Origin provides several options for processing multiple files or datasets to create summary reports, from the GUI programming.

- Repeat analysis on multiple files/datasets using an existing Analysis Template™
- Create summary report by appending rows with desired quantities for each file including an image
- Link Analysis Template to a Microsoft Word template for report creation
- Import multiple files into sequential worksheets in your template
- Execute LabTalk script before or after each file, or at end of the batch process

Files...



Analysis Template...

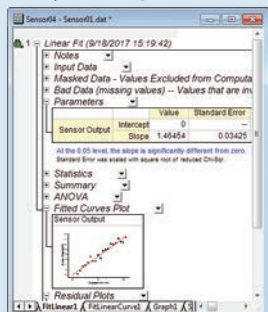

Summary Report with Images

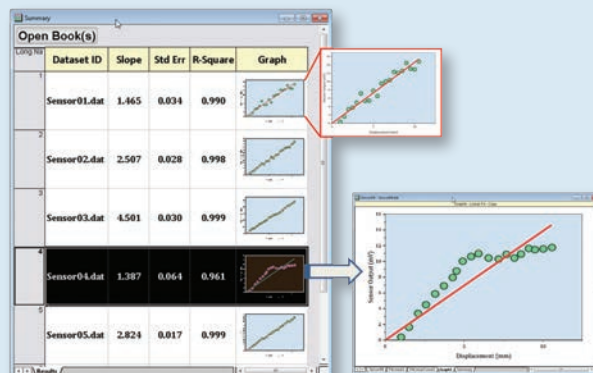

Custom Reports

Use Origin to perform repetitive analysis and create custom reports without any programming.

Origin's new multi-sheet workbooks allow you to format the appearance of cell contents, merge cells and apply borders and other formatting changes. Further, you can paste-link result values from any analysis results and graphs contained in the book or project, thus creating a custom report sheet. With the ability of automatic recalculation of analysis results, your custom report sheets can become templates for repeated tasks—simply import new raw data and watch your custom report automatically update. When your report is ready, export it as a PDF file or as an image file by choosing a popular image format such as EPS and JPEG.

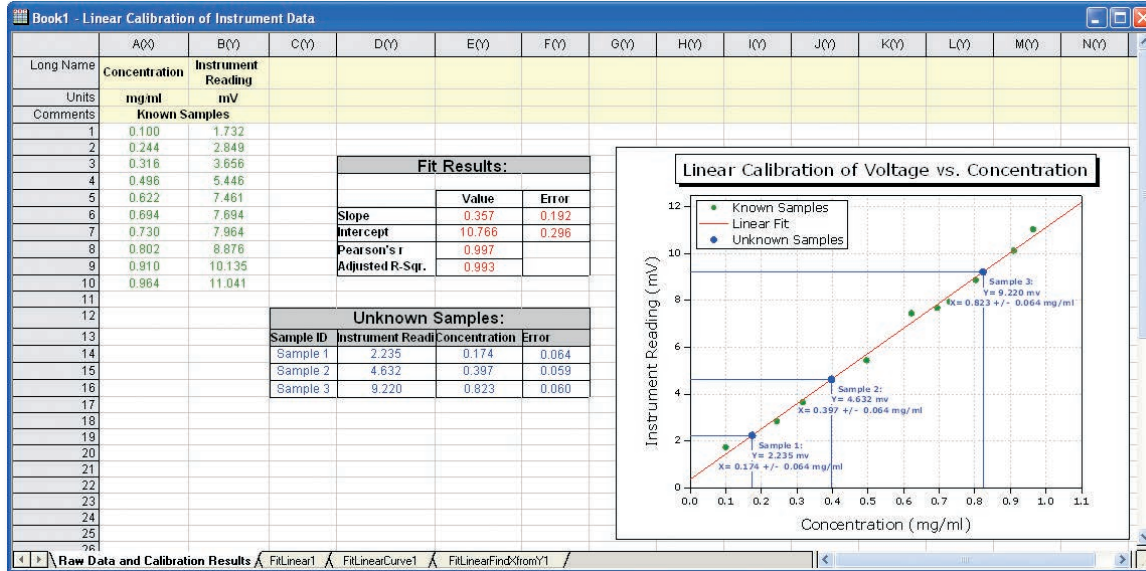

Include data, analysis results and floating graphs in the custom report sheet, it will automatically update when input data is changed

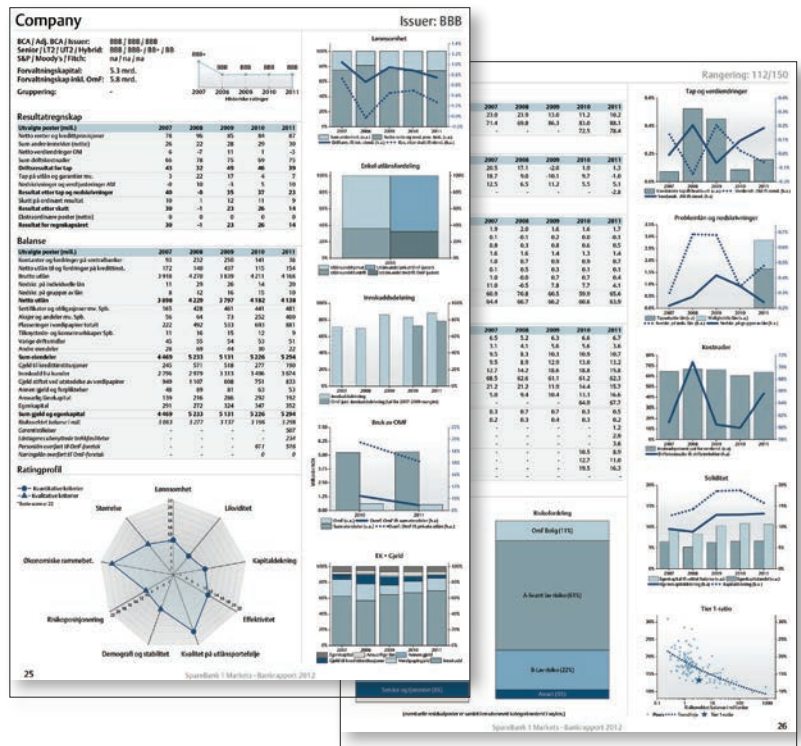
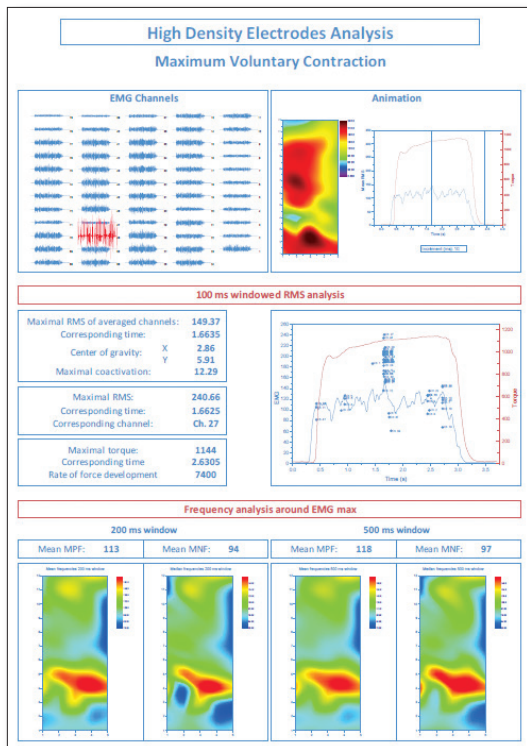

Numerical results, graphs, company logo and other images can all be placed arbitrarily in worksheets to create single or multi-page reports which can then be exported

Publishing

Origin provides a number of tools for preparing files for publication and presentation. Graphs, Worksheets, and Layout pages can be exported with custom settings for publication. Use Origin's built-in slide show capability to present graphs and layout pages, or send to PowerPoint, or copy-paste into other applications. Export graphs, layouts, and worksheets as vector or raster format for submitting to publications.

Exporting Graphs

When you have completed your graph for publication, exporting your final result is very easy with Origin.

- Export presentation quality graphs to a wide variety of formats, including both raster and vector format
- Customize the exporting, to make figures that meet the requirements of publication under a variety of circumstances
- Export graphs to a Microsoft® PowerPoint Slideshow or send graphs directly to a Microsoft PowerPoint presentation

Note that you can also include Origin graphs in other application's files either by pasting or embedding, so that you can later edit these graphs with Origin.

Creating Movies

Origin supports creating movies (AVI file format) from any graph window. A simple tool is provided to configure settings such as compression, and then add individual frames to create the movie. The LabTalk and Origin C programming environments can also be used to create movies, allowing users to integrate movie creation as part of their data processing or computing tasks.

Publishing Custom Reports

Custom reports created by placing numerical results and graphs in an Origin worksheet can be exported as image files. Vector formats such as PDF and raster formats such as PNG are both supported. Reports that occupy more than one page can be exported as multi-page PDF files.

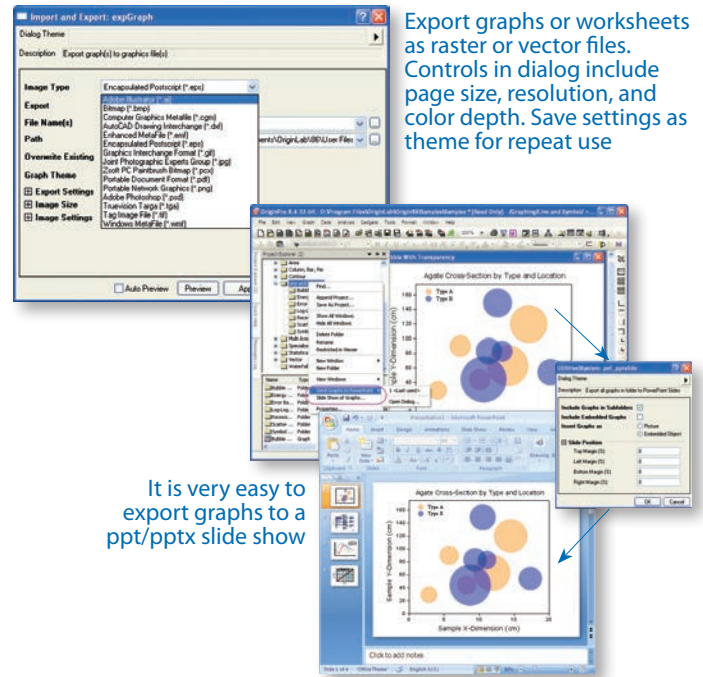

Export graphs or worksheets as raster or vector files. Controls in dialog include page size, resolution, and color depth. Save settings as theme for repeat use

It is very easy to export graphs to a ppt/pptx slide show

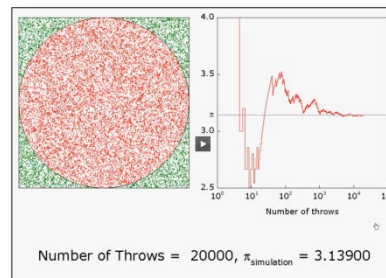

Movie displaying value of π being computed using Monte Carlo method

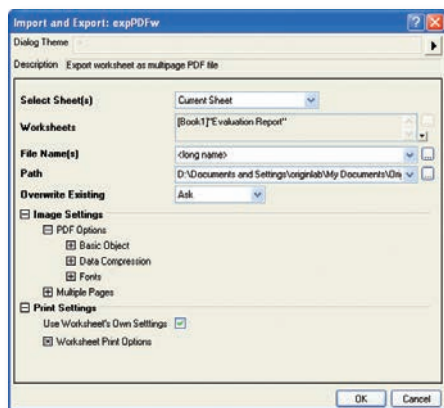

When publishing your custom report, use the PDF export dialog to control font-handling, color translation mode, resolution and compression, page numbering scheme, and other options

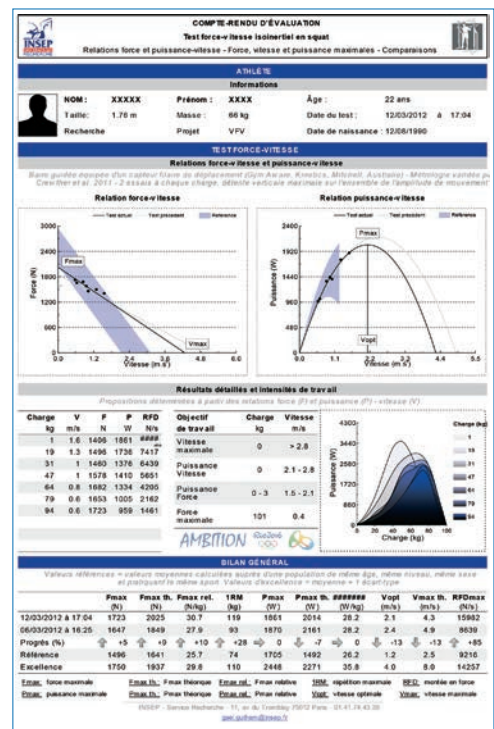

Working with Excel®

Origin provides easy access to your Excel data:

- Copy-paste data from Excel to Origin with full precision
- Import Excel files into Origin worksheets keeping cell formatting and specifying header rows
- Open Excel workbooks directly in Origin
- Optionally save Excel workbooks open in Origin with path relative to the Origin Project (OPJ) file, for easy sharing of OPJ and related Excel files

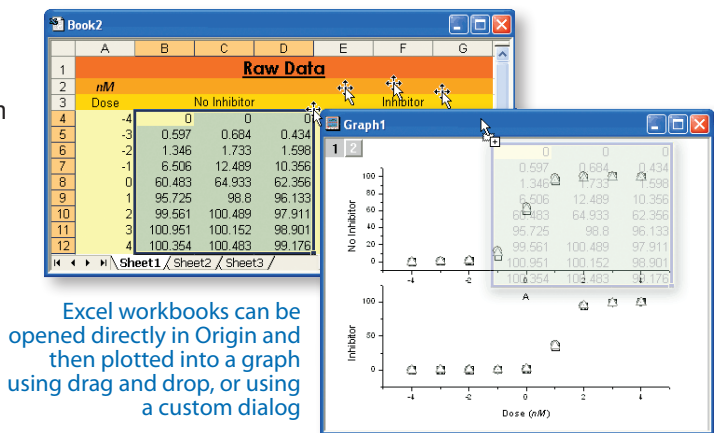

Importing Excel Files, keeping cell formatting, and specifying which rows to treat as header

MATLAB® Connectivity

Importing MATLAB® Files

Origin offers a dialog for importing MATLAB (.mat) files into Origin worksheets and matrices. This import functionality does not require MATLAB to be installed.

MATLAB® Console

If you have MATLAB installed, you can use the Console tool to issue MATLAB commands from within Origin. Buttons and commands are also provided to transfer data from the MATLAB workspace to Origin, and to create MATLAB variables from data in Origin worksheet and matrices.

LabVIEW™ Connectivity

Origin provides a collection of custom LabVIEW sub-VIs that are included in the installation. LabVIEW users can incorporate these custom sub-VIs in their main LabVIEW application to communicate seamlessly with Origin. These sub-VIs take advantage of Origin's automation server classes and can be used for operations such as opening and closing communication with Origin, exchanging data between Origin and LabVIEW, and sending commands to Origin.

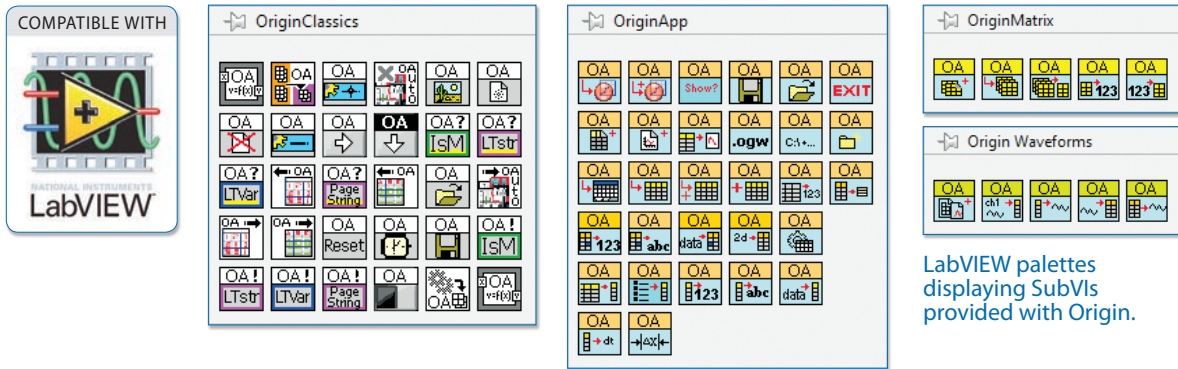

LabVIEW palettes displaying SubVIs provided with Origin.

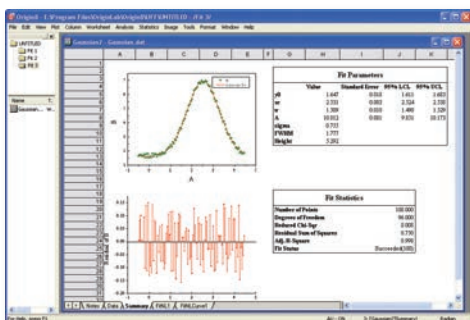
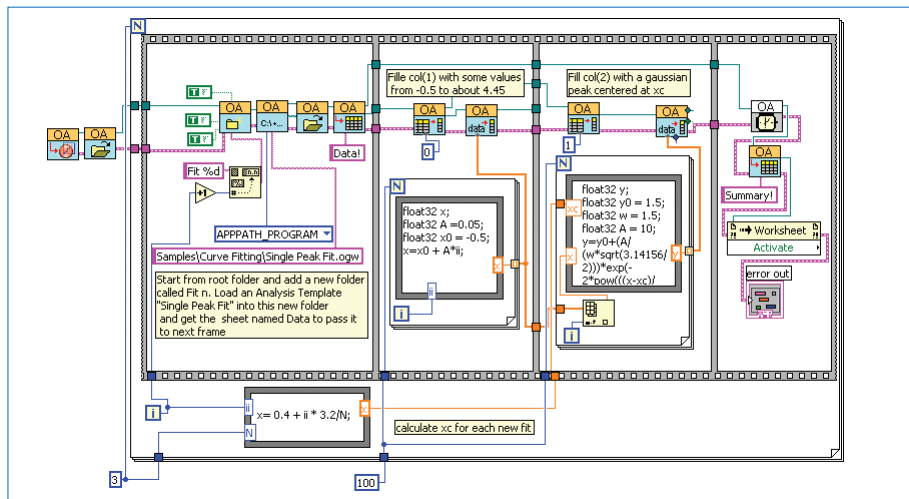

The VI diagram above demonstrates an example of how to perform batch analysis of multiple datasets using an Analysis Template™ in Origin.

In this example, the experimental data has been fitted to a Gaussian curve. The fitted curve, residuals and fit statistics are presented in a user-created report sheet.

Once the VI has executed, the Origin project will have separate subfolders for each dataset. Within each subfolder the Analysis Template™ will contain the raw data, the analysis results, and the custom report sheet ready for printing or exporting.

“Origin can now really augment LabVIEW’s power. The drag-and-drop Origin sub-VIs that come with Origin are simple and easy to use. With Origin’s Analysis Templates™ it is now very simple to create a reusable application that acquires data from third-party instruments, and then passes the data for analysis and report generation to Origin. One can also get curve fit results back into LabVIEW to display in LabVIEW’s charts and graphs on the fly. What’s best is that this is all accomplished in a native LabVIEW environment.”

James T. Gardner, Ph. D., Chief Engineer, Environmental Instruments, Inc.

Programming

LabTalk

LabTalk is a scripting language native to Origin. For simple operations such as manipulating data and automating tasks, LabTalk is a good place to start. You can access a rich set of script commands and functions, including a large collection of X-Functions, to create scripts for your specific needs. Your custom script code can be easily assigned to buttons on graphs or worksheets, new toolbar buttons or custom menu items.

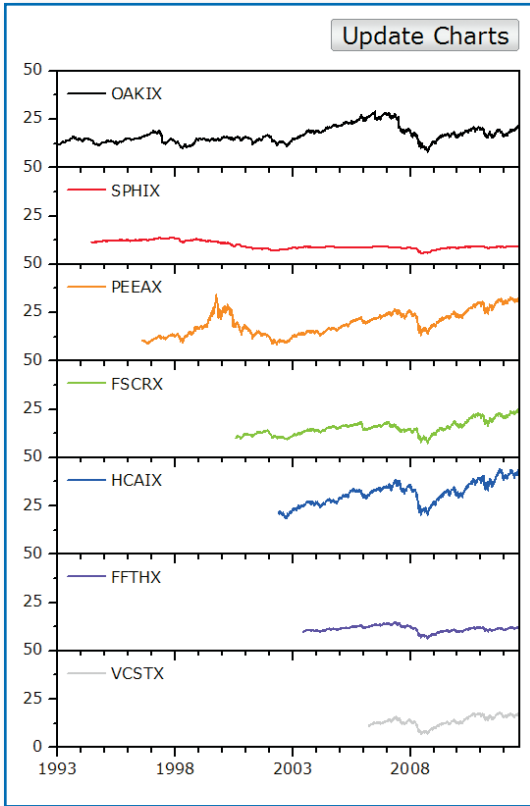

```

Function string strFind(dataset ds, string strVal)
{
    string strTest, strResult;
    for( int ii = 1 ; ii <= ds.GetSize(); ii++)
    {
        if (strTest.Find(strVal) > 0)
        {
            strResult$ = $(strResult$)(CRLF)$(strTest$);
        }
    }
    return strResult$;
}

string MyResult$ = strFind(col(3), "hadron");
MyResult$;

Function int GetMinMax(range rr, ref double min, ref double max)
{
    stats rr;
    min = stats.min;
    max = stats.max;
    return stats.n
}

double y1, y2;
int nn = getminmax(1:end, y1, y2);
type "Worksheet has $(nn) points, min=$(y1), max=$(y2)";
    
```

Classic Script Window displaying LabTalk Script

```

// Call OGS file section to fetch new data
run.section<Stocks, GetNewData>;

// Call section to update report
run.section<Stocks, UpdateReport>;
    
```

Origin graph with text label set up as button for executing LabTalk script. The dialog provides controls such as event handling, and the script to be executed on button-click

Origin C

Origin C is a programming language based on ANSI C, including additional support for C++ and C# features.

With Origin C, you can:

- Create and access properties of all Origin objects such as worksheets, matrices and graphs
- Automate your data analysis and graphing tasks
- Link to external dynamic link libraries (DLL)
- Call C or Fortran library routines, such as the NAG library functions included with Origin, or other public-domain libraries

Origin provides a state-of-the-art integrated development environment called Code Builder for managing your Origin C projects.

```

// Example program calling NAG function using non-iterational array arguments
int SimpleIndex(double dx)
{
    // Example program calling NAG function using non-iterational array arguments
    int n;
    double dData, dD, dDmax, dDmin, dDmax, dDmin, dDmax, dDmin;
    // ... (rest of the code)
}
    
```

Origin C code displayed in Code Builder, Origin's integrated development environment

Python

Origin provides an embedded Python environment so that you can either run Python in Origin, or use a PyOrigin module to access Origin from Python.

R

Origin provides R Console and support for Rserve to exchange data between Origin and R.

Building Dialogs

Create dialog boxes and custom interfaces using standard HTML, CSS and JavaScript. Embed Origin graphs with interactive controls such as cursors and ROI objects. Call JavaScript functions from Origin C and call Origin C methods from JavaScript.

Custom tools can be packaged with all associated files as an App. Simply drag-and-drop the App on an Origin installation to add the custom capability.



The "Origin Central" dialog is built using HTML and JavaScript

```
//this is the function to call JavaScript
BOOL GetGraphControlRect(RECT& rectGraph)
{
    if (!m_dhtml)
        return false;
    Object jscript = m_dhtml.GetScript();

    if (!jscript) //check the validity of returned COM object
        return false;

    string str = jscript.getGraphControlRect();
    JSON.FromString(rectGraph, str); //convert string to a structure
    return true;
}
```

Origin C code to call a JavaScript function

```
<script>
function getGraphControlRect()

var leftDiv = document.getElementById("leftcontainer");
var leftpos = leftDiv.getBoundingClientRect().right;
var toppos = leftDiv.getBoundingClientRect().top;
var bottompos = leftDiv.getBoundingClientRect().bottom;

var rightDiv = document.getElementById("rightcontainer");
var rightpos = rightDiv.getBoundingClientRect().left;

return JSON.stringify({
    left: leftpos + 20,
    top: toppos + 20,
    right: rightpos - 20,
    bottom: bottompos - 20});
}
</script>
```

JavaScript function returning JSON string to Origin C



Origin/OriginPro includes the complete NAG Mark 9 numerical library. This library provides proven numerical functions in areas such as Statistics, Linear Algebra, Regression, Fourier transforms and much more. All functions are accessible from Origin C, and this allows you to develop complex applications that require advanced numerical calculations.

- Complex Arithmetic
- Zeros of Polynomials
- Roots of One or More Transcendental Equations
- Fourier Transforms
- Wavelet Transforms
- Quadrature
- Ordinary Differential Equations
- Partial Differential Equations
- Mesh Generation
- Interpolation
- Curve and Surface Fitting
- Minimizing or Maximizing a Function
- Global Optimization of a Function
- Linear Algebra
- Matrix Factorizations
- Eigenvalues and Eigenvectors
- Determinants
- Simultaneous Linear Equations
- Linear Algebra Support Functions
- Linear Equations (LAPACK)
- Least-squares and Eigenvalue Problems (LAPACK)
- Large Scale Linear Systems
- Large Scale Eigenproblems
- NAG Interface to BLAS
- Simple Calculations on Statistical Data
- Correlation and Regression Analysis
- Multivariate Methods
- Analysis of Variance
- Random Number Generators
- Univariate Estimation
- Nonparametric Statistics
- Smoothing in Statistics
- Contingency Table Analysis
- Survival Analysis
- Time Series Analysis
- Operations Research
- Sorting and Searching
- Approximations of Special Functions
- Mathematical Constants
- Machine Constants
- Input/Output Utilities

Programming

X-Functions

X-Functions provide a framework for building custom tools in Origin. Simply define what controls you want in your dialog and Origin will create the tool from your definition. You provide the Origin C code to be executed by the tool for performing your custom task. Once an X-Function is created, it can be placed in the Origin menu, accessed from LabTalk script, and shared with other Origin users.

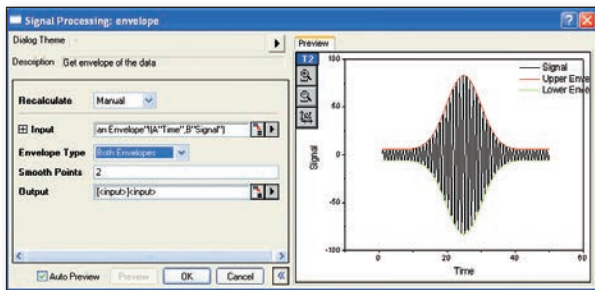
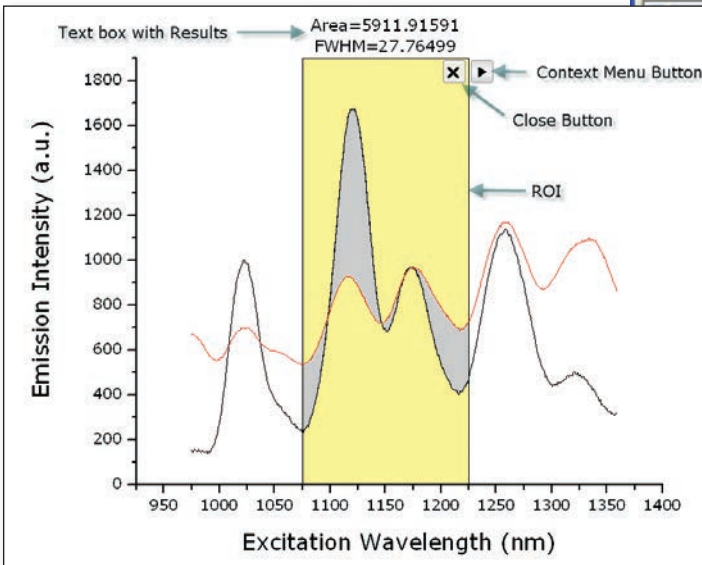
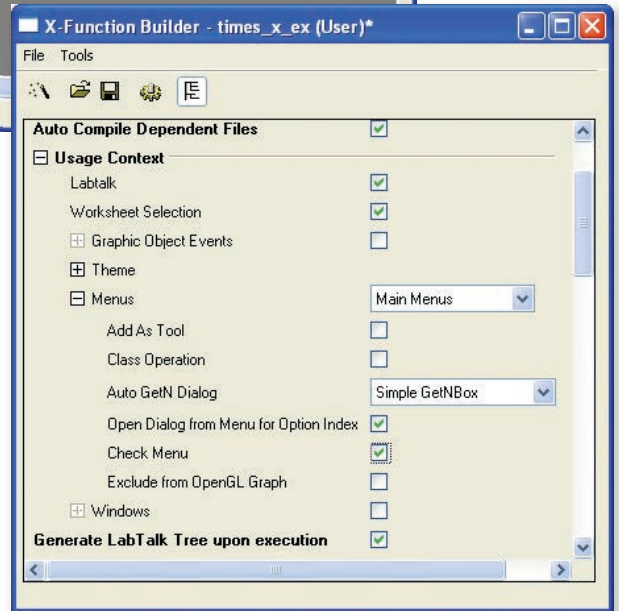
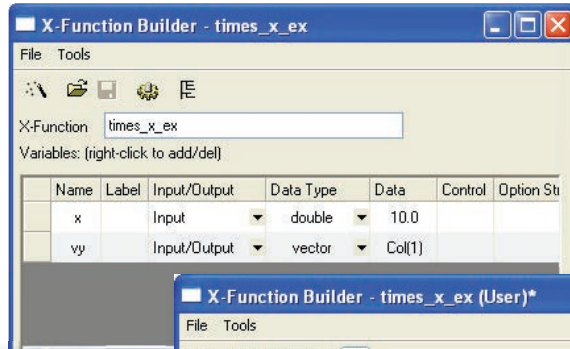

X-Function dialog with preview panel

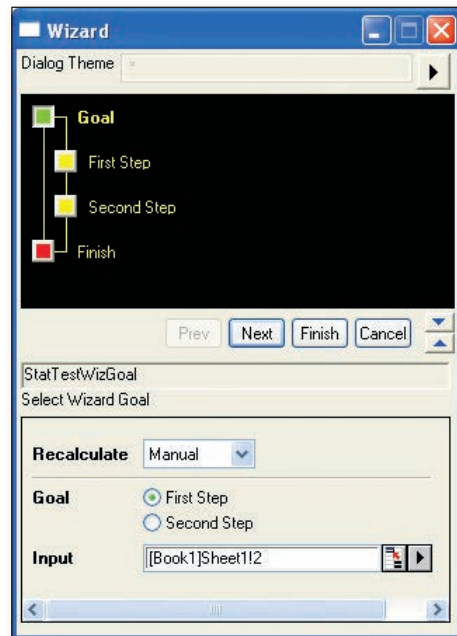

Automation Server

Origin can be accessed as an automation server from client applications such as Excel, LabVIEW, MATLAB, or custom tools built using Visual Basic® or Visual C++ .NET. Data can be streamed into Origin and graphed, and tools in Origin such as Gadgets can be used to perform analysis on the incoming data. Post analysis of data can also be performed by pushing data into Analysis Templates™.

This example illustrates connecting an Excel Client application to Origin:

- Origin is launched and a previously customized Origin Project is opened
- Data is sent from Excel to Origin
- Analysis results are automatically updated by Origin on data change
- Analysis results and graph images are fetched back to Excel from Origin

The figure illustrates the automation process. The top window is Microsoft Excel with a spreadsheet containing two columns: 'Raw Data' and 'Output'. The 'Raw Data' column has sub-columns for 'X', 'Y', 'New X', and 'Interpolated'. The 'Output' column has a sub-column for 'Y'. Below the spreadsheet, an Origin window displays a graph of the data points with a fitted curve. To the right of the Origin window is a dialog box titled 'Connect Origin and Interpolate' with buttons for 'Interpolate', 'Disconnect Origin', and 'Disconnect and Close Origin'. At the bottom, a VBA code window shows the following code:

```

NOTE: ThisWorkbook.App is declared as public, in ThisWorkbook code
Code for "Open Origin Analysis Template" command button
=====
Private Sub CommandButton1_Click()
    'Check if you choose to see if user wants to launch new instance or try connecting
    'to an existing instance
    If (OptionButton1.Value) Then
        On Error GoTo ErrMsg1
        'Launch a new instance of Origin and connect to it.
        Set ThisWorkbook.App = New Origin.Application
    Else
        On Error GoTo ErrMsg1
        'If no instance of Origin is already present, connect to it.
        'Otherwise launch a new instance and connect to it
        Set ThisWorkbook.App = New Origin.Application
    End If
    'Successfully connected to Origin.
    'Show/Hide appropriate controls
    CommandButton1.Enabled = False
    CommandButton2.Enabled = True
    CommandButton3.Enabled = True
    CommandButton4.Enabled = True
End Sub
'Hide this visible
ThisWorkbook.App.Visible = MAINWND_SHOW
'Load a specific Analysis template for performing the computation and graphing
'and loading OPI, show user message to save current work if dirty flag is set
If (ThisWorkbook.App.IsModified) Then
    'Ask user to go to Origin, save the project, and come back to Excel
    MsgBox ("The project currently open in Origin needs to be saved." & vbCrLf & "On to Origin and save the project if needed." & vbCrLf & "Click OK button below to continue.")
    'Repeat the dirty flag, this is actually not needed since NewProject will reset it below
    ThisWorkbook.App.IsModified = False
End If
'Loading of ope will appear ok, so to ensure proper book about name
'we needed about a new project
ThisWorkbook.App.NewProject
'Now load a sample Analysis template for performing the computation
Dim strFile As String
strFile = ThisWorkbook.Path & "1Interpolation.opj"
If Not (ThisWorkbook.App.Load(strFile)) Then
    Dim strOut As String

```

Orglab

Orglab is a freely distributed component DLL for directly creating or reading Origin Projects (.OPJ) and Origin Window files (.OGG, .OGW and .OGM). An Origin license is not required to use Orglab, and this enables equipment manufacturers and other third-party vendors to save their data as Origin file types.

Download for free at: originlab.com/Orglab



The Origin Viewer is a freely distributed stand-alone application created using the Orglab component DLL. The Viewer allows you to view Origin Project files on computers that do not have Origin installed.

Download the Viewer for free: originlab.com/Viewer

User Case Studies

Using Origin to Analyze and Report on Athlete Performance

Antoine Couturier and Sylvain Dorel, researchers at the Institut National du Sport, de l'Expertise et de la Performance in France, have been using the expanded functionality of the Origin Worksheet to produce clean, professional reports for trainers and athletes to review progress in their training regimens.

The researchers import all of the relevant data from the ergocycle into a custom Origin Analysis Template™. The report sheet then automatically fills with the athlete's information, converts the raw data from the ergocycle to Newtons according to ergocycle calibration, detects cycles and half-cycles and computes mean forces, pedaling rates and powers for each of them. All the data corresponding to forces and power vs. pedaling rate are dynamically plotted and fitted using the Analysis Template™.

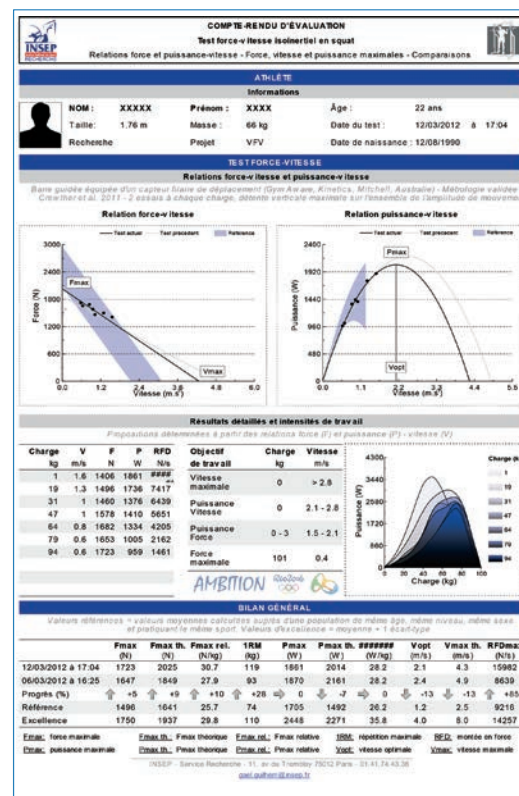

Antoine Couturier says: "Origin is our number one software for visualizing and analyzing experimental data."

Starting from version 8, with the introduction of Analysis Templates™ and custom report, Origin has also become a fantastic tool for scientific coaching of our athletes from the National Institute of Sports, in many disciplines.

Most of the data recorded during the testings are simply drag and dropped into Origin. In a matter of minutes, a database is updated and a complete report is generated for the coaches, including athlete's own progression and comparison to others.

Those unique features have been constantly evolving and allowed us to gain considerable firepower."

Using Origin to Teach Data Analysis and Presentation

Jay Deiner, Ph.D. Assistant Professor of Chemistry NYC College of Technology, City University of New York

Dr. Jay Deiner first started using Origin in 1998 as a graduate student; now, as a professor, he uses it for both his research, and to supplement the advanced chemistry classes he teaches. For example, his students use Origin's analysis features such as peak integration, baseline correction and data picking, to process spectroscopic and chromatographic data. In order to present the final results in an accessible manner they customize their graphs using Origin's comprehensive formatting features.

Jay Deiner says: "I believe that using Origin benefits the students because they learn how to use a sophisticated data analysis program that they may encounter in future work in academic research or in industry. It also enables them to extract much more information from the data they generate. Finally, it helps students understand that much of science is thinking and data analysis. Using Origin benefits me as an instructor because I can teach the class in a more rigorous way."

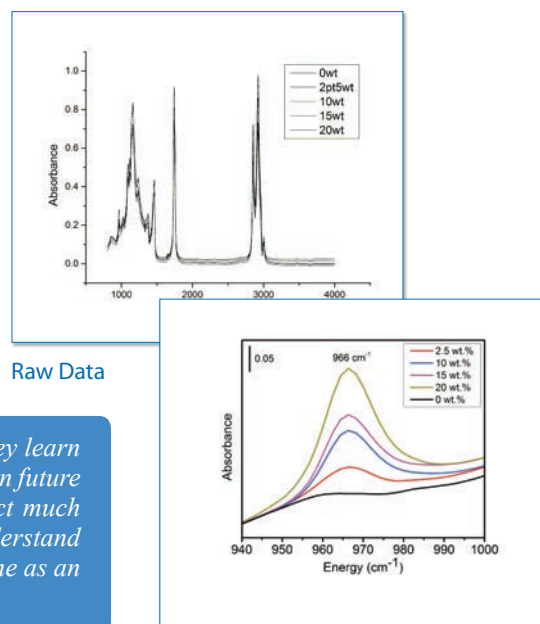

Processed

Origin C++ for Theoretical and Experimental Projects

Mark Kuzyk, Ph.D., Regents Professor of Physics and Astronomy, Washington State University

Dr. Kuzyk and his graduate students at the WSU Physics department use Origin extensively for both theoretical and experimental research on non-linear optics. The Origin C++ feature is convenient for running Monte Carlo calculations, creating plotting functions and automating the process of importing huge volumes of experimental data from experiments that run nonstop for days.

Mark Kuzyk says: "Origin provides a broad pallet of features, giving the students the ability to do just about anything without a huge learning curve. A few years back, an undergraduate student started working with me on a theoretical research project. I set him up with a copy of Origin, and within 12 months he had become an expert in Origin C++, using it to complete a set of calculations that became the basis of a paper that recently appeared in Physical Review A. By the time he graduated, he had won several prizes in poster and paper competitions."

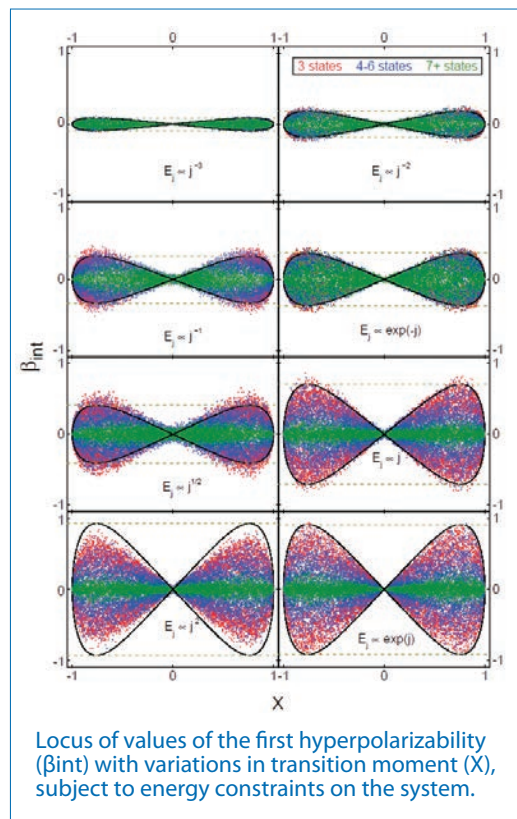

Locus of values of the first hyperpolarizability (β_{int}) with variations in transition moment (X), subject to energy constraints on the system.

Origin as a Financial Reporting Tool

Ariel Fischer, Quantitative Analyst, SpareBank 1 Markets AS, Oslo, Norway

Ariel Fischer and his team are using Origin to construct complex analytical reports that support easy access to financial models and data from different parts of the organization.

Origin met all of their requirements:

- Be flexible, scalable, and easy to modify
- Support automation
- Output publication quality reports
- Handle large amounts of data
- Support different input/output interfaces
- Interface with MATLAB
- Provide aesthetically pleasing reports

This solution has been used to create a credit rating report of 150 Nordic banks. The report is designed to include a summary of financial reports of each bank as well as present and explain the derived credit rating from the underlying credit model. In addition, analysis of aggregated statistics is presented as a function of time. Once new financial data is registered in their data warehouse, an updated credit rating report is created by the click of a button.

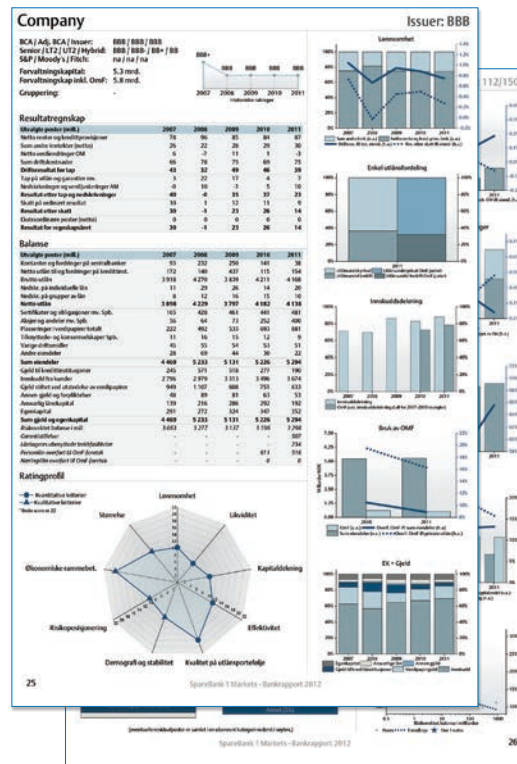

Ariel Fischer says: "The most central Origin feature in this project is the COM-server functionality combined with Origin C and LabTalk, which allows for a seamless integration of Origin with our existing data storage and analysis tools. Additional powerful features of Origin that were utilized include: worksheet queries, animation creation, built-in statistical functions and the import interface. Origin proved to be all-in-all the smoothest way to manage the different elements in the report. The quality of the output is beyond what I have seen in other graphing/analysis-software."

Comparison of Origin and OriginPro

OriginPro provides all of the features of Origin, plus additional analysis tools and capabilities. The following tables provide comparisons between Origin and OriginPro in such areas as curve fitting, peak analysis, statistics, signal analysis, and image handling.*

Curve Fitting		Origin	OriginPro
Linear and Polynomial Fitting	Linear Regression	✓	✓
	Linear Fit with X Error		✓
	Confidence Ellipse for Linear Fit	✓	✓
	Polynomial Regression	✓	✓
	Multiple Linear Regression	✓	✓
	Partial Leverage Plots in Multiple Regression	✓	✓
	Residual Analysis	✓	✓
Nonlinear Fitting	Fitting Multiple Datasets	✓	✓
	Built-in Fitting Function and User-defined Fitting Function	✓	✓
	Parameter Initialization and Derived Parameter Definition	✓	✓
	Bounds and Constraints	✓	✓
	Weighted Fitting	✓	✓
	Fitting with Y Error	✓	✓
	Fitting with X and Y Errors (Orthogonal Regression)		✓
	Global Fit with Parameter Sharing	✓	✓
	Global Fit with Parameter Sharing among Different Functions		✓
	Fitting Replica Data	✓	✓
	Residual Analysis	✓	✓
	Fitting with Implicit Functions (Orthogonal Distance Regression)		✓
	Fitting Comparison		✓
	Fit and Rank Multiple Models		✓
	Surface Fitting		✓
Mathematics		Origin	OriginPro
Simple Mathematics Operations	Simple Mathematics Operations on or Between Datasets	✓	✓
	Set Cell, Column or Matrix Values by Using Mathematics Operations	✓	✓
	Normalization	✓	✓
Interpolation and Extrapolation	1D Interpolation and Extrapolation	✓	✓
	Interpolation and Extrapolation of Y From X	✓	✓
	Trace Interpolation on XY Data	✓	✓
	Trace Interpolation on XYZ Data	✓	✓
	2D Interpolation and Extrapolation	✓	✓
	3D Interpolation	✓	✓
Differentiation and Integration	Numerical Differentiation	✓	✓
	1D Numerical Integration	✓	✓
	2D Volume Integration		✓
Area Calculation	Polygon Area	✓	✓
	XYZ Surface Area		✓
	Matrix Surface Area		✓
Others	Average Multiple Curves	✓	✓
	Inverse of a Matrix	✓	✓

Statistics		Origin	OriginPro
Descriptive Statistics	Basic Descriptive Statistics	✓	✓
	1D and 2D Frequency Counts	✓	✓
	Correlation Coefficient		✓
	Partial Correlation Coefficient		✓
	Cross Tabulation		✓
	Discrete Frequency	✓	✓
	Distribution Fit		✓
	Normality Test (Shapiro-Wilk, Lilliefors, Kolmogorov-Smirnov, Anderson-Darling, D'Agostino-K Squared, Chen-Shapiro)	✓	✓
	Statistics Charts: Histogram, Box Chart, Scatter Matrix, QC Chart, Probability Plot, Q-Q Plot, and Pareto Chart	✓	✓
	Grubbs Test and Q-test to Detect Outliers	✓	✓
	Hypothesis Testing	One Sample and Two-Sample t-Test, Pair-Sample t-Test	✓
Two Sample and Paired-Sample t-Test on Rows			✓
One Sample and Two Sample Hypothesis Tests for Variance			✓
One and Two-Proportion Test			✓
Analysis of Variance	One Way ANOVA, Two Way ANOVA	✓	✓
	Three Way ANOVA		✓
	ANOVA: Mean Comparison (Tukey, Bonferroni, Scheffe, Dunn-Sidak, Fisher LSD, Holm-Bonferroni, Holm-Sidak)	✓	✓
	One Way and Two Way Repeated Measure ANOVA		✓
Nonparametric Tests	Sign Test		✓
	Wilcoxon Test for One Sample and Paired Sample		✓
	Two Sample Kolmogorov-Smirnov Test		✓
	Mann-Whitney Test		✓
	Kruskal-Wallis ANOVA		✓
	Mood's Median Test		✓
	Friedman ANOVA		✓
	Principal Component Analysis		✓
Multivariate Analysis	Cluster Analysis		✓
	Discriminant Analysis		✓
	Canonical Discriminant Analysis		✓
	Partial Least Squares		✓
Survival Analysis	Kaplan-Meier Estimator		✓
	Test Equality of Survival Functions (Log-Rank, Breslow and Tarone-Ware)		✓
	Cox Proportional Hazard Model		✓
	Weibull Fit		✓
Power and Sample Size	One, Two and Paired-Sample t-Test, One Way ANOVA, One and Two-Proportion Test, One and Two-Variance Test		✓
ROC Curve	ROC Curve		✓
Peak Analysis		Origin	OriginPro
Peak Analysis	Baseline Detection	✓	✓
	Baseline Subtraction	✓	✓
	Peak Finding	✓	✓
	Peak Integration	✓	✓
	Peak Fitting		✓
	Fit Baseline with Peaks		✓
	Fit Individual Peaks with Different Fitting Functions		✓
	Batch Peak Analysis		✓

Signal Analysis		Origin	OriginPro
Smoothing and Filtering	Smoothing using Savitzky-Golay Filter, Adjacent Averaging, FFT Filter, and Percentile Filter	✓	✓
	FFT Filters: Low Pass, Low Pass Parabolic, High Pass, Band Pass, Band Block, and Threshold	✓	✓
	IIR Filter Design		✓
Fast Fourier Transform (FFT)	FFT with Basic Options	✓	✓
	2D FFT and 2D FFT Basic Filtering		✓
	Short-Time Fourier Transform (STFT)		✓
Wavelet Analysis	Discrete Wavelet Transform (DWT) and Inverse Discrete Wavelet Transform (IDWT)		✓
	Wavelet Smoothing		✓
	Wavelet Denoising		✓
	Continuous Wavelet Transform (CWT)		✓
Others	Evaluation of Continuous Wavelet Function		✓
	Convolution and Deconvolution	✓	✓
	Coherence		✓
	1D Correlation	✓	✓
	2D Correlation		✓
	Hilbert Transform		✓
	Signal Envelope		✓
	Signal Decimation		✓
Rise and Fall Time Analysis		✓	
Data Manipulation		Origin	OriginPro
Reorganization	Sort Worksheet or Columns	✓	✓
	Stack and Unstack Columns	✓	✓
	Pivot Table	✓	✓
	Split and Append Worksheet	✓	✓
Transformation	Converting XYZ Data to a Matrix	✓	✓
	Transpose Worksheet or Matrix	✓	✓
	Shrink or Expand a Matrix	✓	✓
Extraction and Reduction	Worksheet Query	✓	✓
	Reduce Duplicate X Data	✓	✓
	Reduce Data by Skipping Every N Points	✓	✓
	Reduce Data to Evenly Spaced X	✓	✓
	Reduce XY Data by Group	✓	✓
Others	Find and Replace Numeric and Text Values	✓	✓
	Translate Curve Vertically or Horizontally	✓	✓
	Data Filter for Worksheets	✓	✓
	Select or Hide Columns in Worksheet by Column Label	✓	✓
Gadget		Origin	OriginPro
Gadgets	Surface Integration Gadget		✓
	Global Vertical Cursor Gadget Across Graphs	✓	✓
	Intersect Gadget	✓	✓
	Quick Sigmoidal Fit Gadget	✓	✓
	Cluster Gadget		✓
	Quick Peaks Gadget	✓	✓
	Differentiate and Interpolate Gadget	✓	✓
	Quick Fit Gadget	✓	✓
	Rise Time Gadget		✓
	Integrate, FFT and Statistics Gadget	✓	✓

Apps		Origin	OriginPro	
Curve Fitting	Global Fit with Multiple Functions		✓	
	Polynomial Surface Fit		✓	
	Sequential Fit		✓	
	Piecewise Fit		✓	
	General Linear Regression		✓	
	Composite Spectrum Regression		✓	
	Cyclic Voltammetry		✓	
	Find a Fitting Function	✓	✓	
	Simple Fit	✓	✓	
	Compare Linear Fit Parameters and Datasets	✓	✓	
	Peak Analysis	Global Peak Fit		✓
		Peak Deconvolution		✓
Align Peaks		✓	✓	
Mathematics	Equations Solver		✓	
	Tangent	✓	✓	
	Tafel Extrapolation	✓	✓	
	Distance Between Two Points	✓	✓	
	Level Crossing	✓	✓	
Signal Processing	Independent Component Analysis		✓	
	Time-Frequency Analysis		✓	
	Fourier Self-Deconvolution		✓	
	FFT Examiner		✓	
Statistics	Design of Experiments		✓	
	Gaussian Mixture Models		✓	
	Simple Time Series Analysis		✓	
	Logistic Regression		✓	
	Principal Component Analysis for Spectroscopy		✓	
	Post-hoc Analysis for Nonparametric Tests		✓	
	Statistics Advisor	✓	✓	
	Graph Customization	Color Editor	✓	✓
LaTeX		✓	✓	
Google Map Import		✓	✓	
Maps Online		✓	✓	
Layer Stack Manager		✓	✓	
Graphing	Means Plot		✓	
	Heat Map with Dendrogram		✓	
	Graph Maker	✓	✓	
	Batch Plotting	✓	✓	
	Paired Comparison Plot	✓	✓	
	Kernel Density for Polar and Ternary	✓	✓	
	3D Wall Profile	✓	✓	
	Zoomed Inset	✓	✓	
Data Processing	Data Slicer	✓	✓	
	OPJ Searcher	✓	✓	
Import and Export	Import Chem Data		✓	
	Graph Publisher	✓	✓	
	Import LSM	✓	✓	
	Movie Creator	✓	✓	
	Send Graphs to Word	✓	✓	

Licensing

Licenses Available to all Customers

OriginLab offers a variety of Origin and OriginPro individual and multi-user packages for customers in the commercial, academic, non-profit, and government sectors.

Package	For	Description
Individual	Single user.	Available as Origin or OriginPro. Permanent package. Node-locked (fixed seat, computer-specific) license.
Group	Group of users at your organization.	Available as Origin or OriginPro. Permanent package. Node-locked (fixed seat, computer-specific) licenses, or FlexNet concurrent (floating) licenses.
Site	A large group of users within an organization. A site can be one or more departments at the same physical location (including a research center involving multiple departments), or the entire organization / campus.	Available as Origin or OriginPro. Permanent package. Node-locked (fixed seat, computer-specific) licenses, or FlexNet concurrent (floating) licenses.

Additional Licenses Available to Academic Customers

In addition to the packages mentioned above, OriginLab offers the following specially priced packages for academic customers:

Package	For	Description
Research Lab	Research groups involving a faculty member and multiple post-docs, staff members and students.	Available as Origin or OriginPro. Perpetual or time-limited to one year. Node-locked or Concurrent Network license.
Coursework	Student instruction within classroom.	OriginPro Learning Edition Free for students. 6-month OriginPro license provided to instructor. Node-locked license.
Laboratory	Student instruction within laboratory.	OriginPro. Time-limited to one year. Renewal can be synchronized with semester schedule. Concurrent Network license. Additional permanent OriginPro license provided to instructor.
Student Version	Student enrolled in a college or university.	OriginPro. Time-limited to 6-months/1-year.

GSA Pricing

For qualifying government customers, OriginLab offers GSA pricing.



OEM Version

Origin is also available to vendors who want to package it with their own products. The Origin OEM version can be directly bundled with your products or it can be customized to meet your specific data analysis and graphing needs.

Over 500,000 Registered Users Worldwide in:

6,000+ Companies including 120+ Fortune Global 500

6,500+ Colleges & Universities

3,000+ Government Agencies & Research Labs

“Case Western Reserve University distributes Origin to students, faculty and staff via a software download website. Members of the University can download, install and activate Origin at their convenience with no help needed from our technical support staff.

We have found the process of implementing Origin on our download site to be easy and pleasant. The Origin installation software was easy to use and our users find the setup and activation process to be trouble free and straightforward. We couldn't be more pleased with the service and support we received from OriginLab.”

Pete Babic, Data Systems Manager, Case Western Reserve University

“The Department of Materials Science and Engineering at the University of Florida strives to produce students who graduate with skills and knowledge for careers or for further education. As part of this mission, we want students in the undergraduate laboratories to use state of the art software, so that they have skills to use the tools they will see in their future endeavors. Origin is a high level, professionally recognized software, and we want our students to learn to use this for preparing data for professional reports, publications, and presentations.”

Nancy Ruzycski, Senior Lecturer, Director of Undergraduate Laboratories, Department of Materials Science and Engineering, University of Florida

“I have been using the OriginPro software in my Instrumental Methods of Analysis class (2nd semester of analytical chemistry). We use it for processing infrared, UV-Vis, GC-MS, and HPLC data.

I chose Origin for several reasons:

- 1) I work with it for research and have found it to be powerful and user friendly.*
- 2) Origin is a software tool that is very common in research labs. It is important for students to become familiar with it.*
- 3) Origin offers a very large variety of options for graphing complicated data in a way that makes it straightforward for the reader/audience to understand.*
- 4) The academic 10-pack lease was affordable.”*

Jay Deiner, Assistant Professor of Chemistry, NYC College of Technology, City University of New York

“In our lab, students learn how to present data in a professional fashion, and how to use fitting for data analysis to find system parameters. These skills should help students in their professional engineering and research careers. For me as an instructor, using Origin is an effective way to present lecture material (in other classes), introduce students to new software that is somewhat exciting for students, and to have students coming to my research lab for undergraduate (and potentially for graduate) research prepared to use Origin (which I use in my research).”

Alexei Grigoriev, Department of Physics and Engineering Physics, University of Tulsa

Product Support

Standard support is available to:

- All registered customers with maintenance. (For most packages, the first year of maintenance is included at the time of purchase.)
- All customers evaluating our products.

Support is available Monday - Friday by phone, e-mail and online chat from 8:30 AM to 6:00 PM EST. Extended support hours from 7:30 PM to 4:00 AM EST are available for online chat and e-mail.

Support resources are also available from the OriginLab website, including video tutorials, FAQs, and a product forum.

“My interaction with the OriginLab Technical Support team was excellent! The team was immediately responsive and very cordial. The team diagnosed and solved the problem immediately. Team members are by far the best in the business.”

Ray Huffaker - Professor and Chair, Food and Resource Economics Department, Institute of Food and Agricultural Sciences, University of Florida

“Origin is an extremely powerful software package and their technical support has been very responsive. As a new Origin user it has reduced my learning curve tremendously. Between the online videos and rapid replies to my e-mails I have been extremely pleased.”

Nigel Clark - NOVA Chemicals

Note: These opinions are personal opinions and do not imply any statement or endorsement by NOVA Chemicals.

“Great support from the OriginLab team! I quickly reached the correct technical support person, he was able to answer my questions, and he followed-up with an email which included an example project & written explanation. This type of quick, personal support is one of the key reasons I have used Origin for the past 10 years.”

Eric Scharin - Zogenix, Inc.

Origin Blog

Read our blog for tips and ideas on using Origin. New entries are added regularly: blog.originlab.com

Training Webinars

Register for our periodic webinars covering graphing and analysis using Origin, or view recordings of past webinars: originlab.com/Webinars

User Forums

Our forums contain more than 20,000 posts. Questions are answered daily by OriginLab staff and by other Origin users: originlab.com/Forum

File Exchange

Origin File Exchange contains over 100 entries including Apps, Tools, Templates, Fitting Functions and Examples, provided by OriginLab and the Origin user community: originlab.com/FileExchange



The image displays three screenshots of the OriginLab website. The top screenshot shows the 'OriginBlog' page with a 'Latest Posts' section featuring a 'Donut Chart' and a 'Plot Sub-Matrix by Origin' article. The middle screenshot shows the main OriginLab website with navigation tabs for 'Products', 'Purchase', 'Support', 'Communities', and 'About Us'. The bottom screenshot shows the 'Origin File Exchange' page, which lists various user-submitted files and tools, such as 'Heat Map with Dendrogram by Origin' and 'ODE Solver by Origin', each with a rating and download count.

Why Choose OriginLab?

We realize that you have multiple companies and products to choose from for your data analysis and graphing needs. Here are a list of reasons why we think OriginLab is the better choice:

1. Support And Services Beyond The Norm

Our support team members on average have 5+ years of experience helping scientists and engineers with our products. When you contact us, you can rest assured that you will be helped by someone who is very knowledgeable with the product, and is eager to help you.

2. A Well Established Product

Origin and OriginPro are used by over 500,000 scientists and engineers around the world. Year after year, our customer satisfaction survey shows that over 85% of our customers are very happy to recommend Origin to a colleague.

Our R&D team consists of scientists and engineers themselves from a wide variety of disciplines. Each year we publish a new version of Origin and OriginPro, and the features and improvements we introduce are primarily based on customer feedback.

3. A Well Established, And Growing Company

OriginLab has been serving the scientific and engineering community for 25+ years, and is still growing! Our mission is to provide data analysis and graphing software that is flexible and easy-to-use, but at the same time has a range and depth of features that scientists and engineers expect and rely upon for their needs.

OriginLab Services

Maintenance

OriginLab's annual maintenance service includes the following benefits:

- Free Origin and OriginPro upgrades – OriginLab typically publishes one major software release each year.
- Free personal technical support.
- Access to the beta version of our upcoming release.
- Discounts on training and consulting services.

Visit originlab.com/Maintenance to learn more.

Training

Our training programs range from basic training that helps you get started with our products, to advanced training that teaches you how to customize our products to meet your special needs. All training courses are hands-on, providing attendees with the information and expertise to make optimum use of our products.

Visit originlab.com/Training to learn more.

"Bombardier Flight Test Center Engineering have been using Origin for several years. It has served us well. It is always a pleasure working with the OriginLab Team, whether it's to get assistance with special software coding or to train our new employees. As a customer, you make scheduling and conducting the training for our employees, at our facility, so easy. Your support engineers have delivered excellent instruction and technical assistance. Thank you for providing world class support!"

Michael Konicki, Section Chief, Electrical Engineering, Bombardier Flight Test Center

Consulting

OriginLab provides consulting services to customize and enhance Origin to meet your specific analysis and graphing needs. Our Applications engineers will work with you to design and implement your custom Origin solution.

Visit originlab.com/Consulting to learn more.



OriginLab Corporation

One Roundhouse Plaza, Northampton, MA 01060 USA
 USA: 1.800.969.7720, Int'l: 1.413.586.2013, Fax: +1.413.585.0126
 Email: sales@originlab.com

OriginLab®
www.originlab.com